

P1000



240V Class: $\frac{3}{4}$ to 175 HP
480V Class: 1 to 1000 HP
600V Class: 2 to 250 HP



 **YASKAWA**™

The Flexible and Intuitive Solution for Fan and Pump Applications.

The P1000 drive provides simple, reliable, cost-effective control for variable-torque loads through 1000 HP. Specific application features, energy savings, and network connectivity make the P1000 a great choice for industrial fans and pumps.



Contents

Features, Benefits, and Specifications	4	
Drives and Accessories Selection	16	
Mechanical Installation Planning	34	
Electrical Installation Planning	39	
Yaskawa Industrial Drives Family	42	
Global Service Network	44	



Features and Benefits

Exceptional Quality

Enjoy peace of mind by knowing that you are considering a product from Yaskawa, the factory automation controls company with the highest reputation for quality and reliability. Historically, Yaskawa drives have demonstrated extremely high reliability with an average MTBF (mean time between failure) of 28 years or more. The new 1000 series products take reliability to the next level with a calculated design life that is twice as long as previous generations.



Highly Integrated Design results in fewer parts and interconnections, reducing the number of failure points.

Component Derating extends the life of any single part by selecting higher specifications (e.g., voltage, current) than what a circuit requires for normal operation.

Latest Generation IGBT Power Modules, capable of four times more thermal cycles than previous designs.

Enhanced Short Circuit Detection and Self Diagnostics provide additional protection against severe catastrophic conditions.

In addition, the P1000 is designed for use around the world, and carries agency certifications for all major geographical regions



Easy to Apply and Maintain

The P1000 is supported by user-friendly configuration tools. For local field access, the keypad interface features a multi-language LCD display, parameter storage, and application presets to make programming a simple task. It also has built-in memory for backup purposes. In addition, a USB Copy Unit can be loaded with a drive's program for convenient portable transfer of configuration between an office environment and the factory floor.



USB Copy Unit



Fan and Pump Application Presets

Start-up time has been reduced with preprogrammed application presets that allow for simple and easy start-up by answering simple motor and application information.

Application Presets: General Purpose; Pump & Pump with PI Feedback Control; Fan & Fan with PI Feedback Control



DriveWizard® computer software delivers configuration, monitoring, and trending functions enhanced by direct connectivity through the P1000's standard USB port.

- Online and Offline Editing
- Application Wizard
- Monitoring and Diagnostic Panels
- Trend Recorder and Playback
- Network Configurator
- Multidrive Support
- Drive Flash Support
- Project Converter
- Report and Export Generation
- Search Engine



Features and Benefits

Easy to Apply and Maintain

Real Time Clock (RTC)

Take advantage of the battery-backed clock that's built into the P1000's keypad display. With this feature, the P1000 can be controlled based on time of day, and can also provide time-stamped event information.

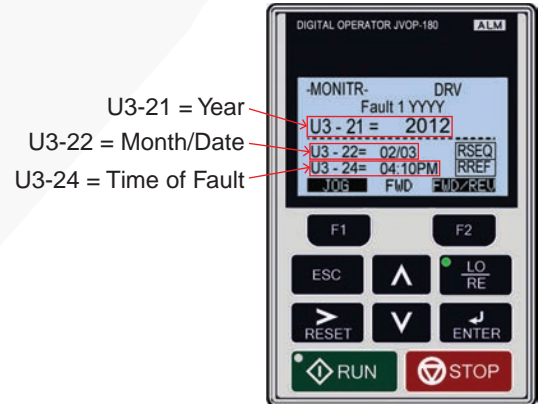

PI Process Control

Two separate process control loops are embedded in the P1000. One modifies drive speed based on setpoint and sensor feedback. A second control loop (with its own setpoint and feedback inputs) can be output to control something completely independent of the drive. Additionally, the P1000 provides a 24VDC, 150mA supply for applying power to sensors.



Selectable and User-Customizable Engineering Units

Allow for easy configuration of keypad display to match process and feedback devices such as PSI, GPM, Feet.

Preventative Maintenance Monitors

Maximize production and intelligently schedule your maintenance by making use of the P1000's special monitors that provide alarm information when a drive requires attention. Use this information to trigger discrete outputs or send the status across a network for upper level decision making.

- Cooling Fan Remaining Life
- IGBT (Power Module) Remaining Life
- Bus Capacitor Remaining Life
- Precharge Relay
- Drive (Heatsink) Temperature

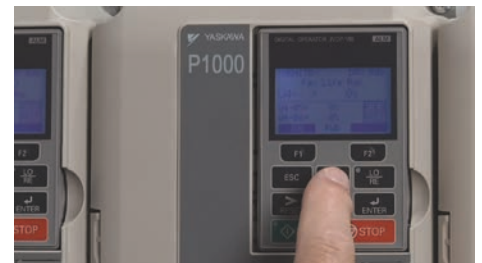

Easy to Apply and Maintain

Highly Reliable and Easily Replaceable Cooling Fans

- Improved location for convenient access, even when mounted with heatsink external
- No tools required
- All ratings are 24Vdc powered



Removeable I/O Terminal Board with Drive Backup Memory

- All parameter changes automatically saved to both main control board and I/O board
- Leave I/O connected when replacing a drive
- Configuration is downloaded to replacement drive
- Reduces MTTR (Mean Time To Repair)

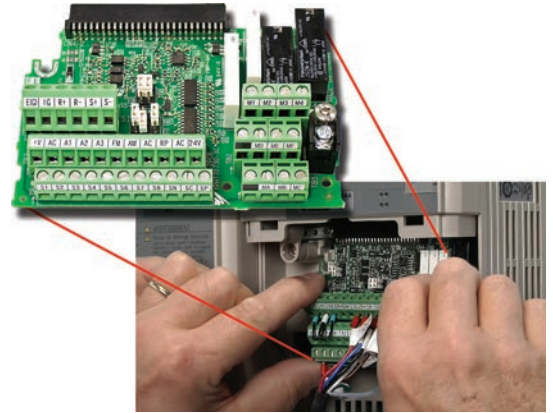

Underload Detection

Monitors the load and will stop the system in the event of a fan belt or pump shaft failure.

Dynamic Noise Control

Monitors the load at all times and reduces the output voltage automatically, reducing motor audible noise.

Features and Benefits

Maximum Flexibility

Enjoy a significant amount of standard control points. The P1000 can also expand to support popular communication networks.



Standard I/O and Communications

- Digital Inputs (8)
- Analog Inputs (3)
- Pulse Inputs (1)
- Digital Outputs (4)
- 2 Form C Relays
- 2 Form A Relays
- Analog Outputs (2)
- RS485 Modbus RTU Communication



Expansion Capability

- Analog Output Module (3 additional outputs)
- DeviceNet
- EtherNet/IP
- Modbus TCP/IP
- PROFIBUS-DP
- PROFINET
- BACnet
- Lonworks
- Metasys (N2)
- Apogee (P1)

Auxiliary Control Power Input

Keep your drives communicating over the network, even while main power is removed. The Auxiliary Control Power Input uses facility supplied 24Vdc to keep the drive's control and communication intact. Service your drive cabinets with the benefit of live control and communications without the need for main power and associated Arc Flash protection.



Maximum Flexibility

Space Saving Features

The P1000 offers world class power density resulting in an average size reduction of 30% as compared to previous generations (see individual rating dimensions). In addition, even more cabinet space can be saved by taking advantage of External Heatsink Mounting and Zero Side Clearance capability.

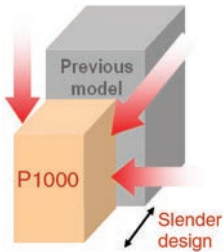

Physical Size Reduction

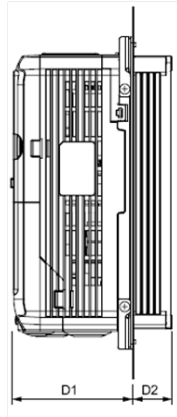

External Heatsink Solution
(Side View)



Zero Side Clearance
(40°C max ambient)

Type 12 Flange Configuration

P1000 is available in all ratings as a Type 12 Flange configuration that allows for mounting the drive with its heatsink out the back of any Type 12 enclosure. This allows for the majority of the drive's heat to dissipate on the external side, while keeping the enclosure small and sealed with Type 12 integrity.



Features and Benefits

Trip-free Operation

Keep your applications running with features designed to avoid interruptions that are typical with demanding load conditions.

- Optimal Decel automatically extends the programmed deceleration time based on the load condition and drive capability.
- Overvoltage Suppression limits the DC bus voltage by modulating output frequency to keep the drive out of the regenerative region.
- Overload Fault Prevention responds to heavy load conditions by adjusting output frequency and voltage to keep the drive's current within operating limits.
- Momentary Power Loss Ride-Thru puts the drive in standby mode during transient power losses and then automatically restarts, avoiding potentially costly power related shut down conditions.
- Bi-directional speed search allows the drive to start into a rotating load by quickly sensing the speed and direction of the motor and then seamlessly matching the drive's output.
- For applications that can dissipate losses in the motor, Over-Excitation Braking and High Slip Braking are good-performing, money-saving alternatives to dynamic braking.
- In the event of a power loss, Kinetic Energy Braking uses energy stored in the rotating load to keep the drive powered and bring the process to a controlled stop.

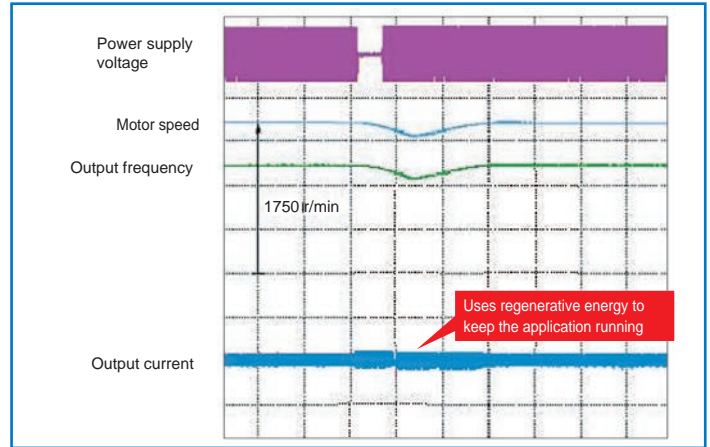

Speed Search

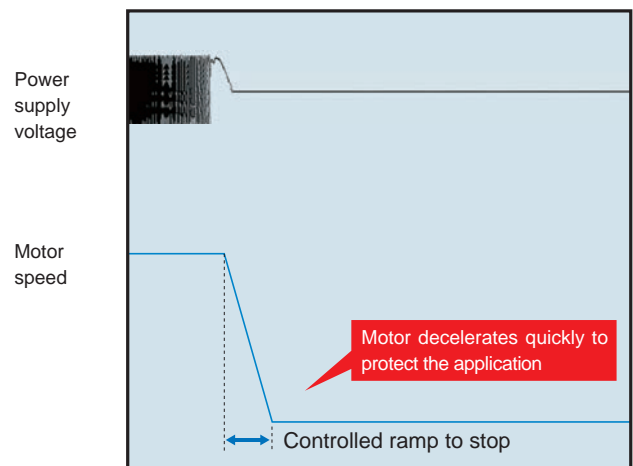

Kinetic Energy Braking

Environmental

Reduce your energy bill and contribute towards a cleaner environment with sustainable features designed into the P1000.

Energy Savings Benefits of Variable Speed

Using variable speed on pumps and fans results in very large energy savings as compared to other fluid or air control methods (valves, guide vanes, dampers, etc.). Additionally, the P1000 provides even greater savings with its Energy Saving Control that reduces unnecessary magnetizing current at reduced speeds.

Power Quality Conscious

Built-in DC reactors (30 HP and larger) provide input harmonics benefit, and protection from input disturbances.

To further reduce harmonics reflected back to the utility power line, the P1000 is available with an integrated 12-pulse diode bridge from 40 to 1000 HP @ 480VAC (also requires the use of an external phase-shifting transformer).

Product Life Cycle Responsibility

The future of our environment and the earth's natural resources is very important to Yaskawa. The P1000 has been designed to minimize the use of harmful materials (e.g. lead, mercury, cadmium, etc.) and meets the requirements of RoHS (Restriction of Hazardous Substances)

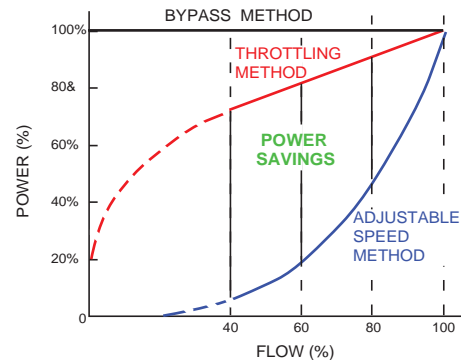

Comparison of Power Requirements for Variable Speed and Throttling method

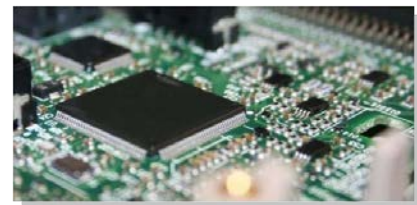
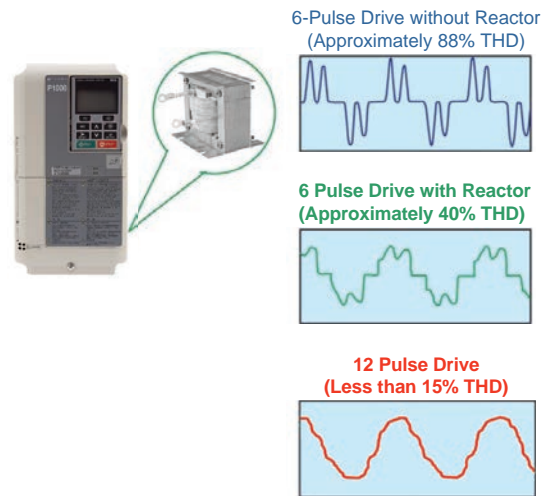

Specifications

240V Class

Model	CIMR-PU2A		0004	0006	0008	0010	0012	0018	0021	0030	0040	0056	
Max. Applicable Motor Capacity ^{*1}	HP		0.75	1.5	2	3	3	5	7.5	10	15	20	
Input	Rated Input Current ^{*2}	A	3.9	7.3	8.8	10.8	13.9	18.5	24	37	52	68	
	Rated Output Capacity ^{*4,*5}	kVA	1.3	2.3	3	3.7	4.6	6.7	8	11.4	15.2	21	
Output	Rated Output Current ^{*5}	A	3.5	6	8	9.6	12	17.5	21	30	40	56	
	Overload Tolerance		120% of rated output current for 60 sec.										
	Carrier Frequency (User Adjustable)		2 to 15 kHz										
	Max. Output Voltage		Three-phase 200 to 240 V (relative to input voltage)										
	Max. Output Frequency		400 Hz										
Power	Rated Voltage/Rated Frequency		Three-phase 200 to 240 Vac 50/60 Hz 270 to 340 Vdc ^{*3}										
	Allowable Voltage Fluctuation		-15% to +10%										
	Allowable Frequency Fluctuation		±5%										
	Fan		No fan					With fan					
	DC Link Choke		External Option										
	Power Supply	kVA	2.2	3.1	4.1	5.8	7.8	9.5	14	18	27	36	

Model	CIMR-PU2A		0069	0081	0110	0138	0169	0211	0250	0312	0360	0415		
Max. Applicable Motor Capacity ^{*1}	HP		25	30	40	50	60	75	100	125	150	175		
Input	Rated Input Current ^{*2}	A	80	96	111	136	164	200	271	324	394	471		
	Rated Output Capacity ^{*4,*5}	kVA	26	31	42	53	64	80	95	119	137	158		
Output	Rated Output Current ^{*5}	A	69	81	110	138	169	211	250	312	360	415		
	Overload Tolerance		120% of rated output current for 60 sec.											
	Carrier Frequency (User Adjustable)		2 to 15 kHz					2 to 10 kHz						
	Max. Output Voltage		Three-phase 200 to 240 V (relative to input voltage)											
	Max. Output Frequency		400 Hz (user-set)											
Power	Rated Voltage/Rated Frequency		Three-phase 200 to 240 Vac 50/60 Hz 270 to 340 Vdc ^{*3}											
	Allowable Voltage Fluctuation		-15% to +10%											
	Allowable Frequency Fluctuation		±5%											
	Fan		With fan											
	DC Link Choke		External Option			Included								
	Power Supply	kVA	44	52	51	62	75	91	124	148	180	215		

*1. The motor capacity (HP) refers to a NEC rated 4-pole motor. The rated output current of the drive output amps should be equal to or greater than the motor current. Select the appropriate capacity drive if operating the motor continuously above motor nameplate current.

*2. Assumes operation at the rated output current. Input current rating varies depending on the power supply transformer, input reactor, wiring connections, and power supply impedance.

*3. Direct application of DC power is not presently supported by the P1000's UL listing.

*4. Rated motor capacity is calculated with a rated output voltage of 230V.

*5. Carrier frequency is set to 2 kHz. Current derating is required in order to raise the carrier frequency.

480V Class

Model	CIMR-PU4A	0002	0004	0005	0007	0009	0011	0018	0023	0031	0038	0044	0058	0072	
Max. Applicable Motor Capacity ^{*1}	HP	1	2	3	3	5	7.5	10	15	20	25	30	40	50	
Input	Rated Input Current ^{*2}	A	2.1	4.3	5.9	8.1	9.4	14	20	24	38	51	60	58	71
	Rated Output Capacity ^{*4,*5}	kVA	1.6	3.1	4.1	5.3	6.7	8.5	13.3	17.5	24	29	34	44	55
Output	Rated Output Current ^{*5}	A	2.1	4.1	5.4	6.9	8.8	11.1	17.5	23	31	38	44	58	72
	Overload Tolerance	120% of rated output current for 60 sec.													
	Carrier Frequency (User Adjustable)	2 to 15 kHz													
	Max. Output Voltage	Three-phase 380 to 480 V (relative to input voltage)													
Power	Max. Output Frequency	400 Hz													
	Rated Voltage/Rated Frequency	Three-phase 380 to 480 Vac 50/60 Hz 510 to 680 Vdc ^{*3}													
	Allowable Voltage Fluctuation	-15% to +10%													
	Allowable Frequency Fluctuation	±5%													
	Fan	No fan					With fan								
	DC Link Choke	External Option												Included	
	Power Supply	kVA	2.3	4.3	6.1	8.1	10	14.5	19.4	28.4	37.5	46.6	54.9	53	64.9

Model	CIMR-PU4A	0088	0103	0139	0165	0208	0250	0296	0362	0414	0515	0675	0930	1200	
Max. Applicable Motor Capacity ^{*1}	HP	60	75	100	125	150	200	250	300	350	450	600	800	1000	
Input	Rated Input Current ^{*2}	A	86	105	142	170	207	248	300	346	410	465	657	922	1158
	Rated Output Capacity ^{*4,*5}	kVA	67	78	106	126	159	191	226	276	316	392	514	709	915
Output	Rated Output Current ^{*5}	A	88	103	139	165	208	250	296	362	414	515	675	930	1200
	Overload Tolerance	120% of rated output current for 60 sec.													
	Carrier Frequency (User Adjustable)	2 to 15 kHz			2 to 10 kHz					2 to 5 kHz					
	Max. Output Voltage	Three-phase 380 to 480 V (relative to input voltage)													
Power	Max. Output Frequency	400 Hz (user-set)													
	Rated Voltage/Rated Frequency	Three-phase 380 to 480 Vac 50/60 Hz 510 to 680 Vdc ^{*3}													
	Allowable Voltage Fluctuation	-15% to +10%													
	Allowable Frequency Fluctuation	±5%													
	Fan	With fan													
	DC Link Choke	Included													
	Power Supply	kVA	78.6	96	130	156	189	227	274	316	375	425	601	843	601

- *1. The motor capacity (HP) refers to a NEC rated 4-pole motor. The rated output current of the drive output amps should be equal to or greater than the motor current. Select the appropriate capacity drive if operating the motor continuously above motor nameplate current.
- *2. Assumes operation at the rated output current. Input current rating varies depending on the power supply transformer, input reactor, wiring connections, and power supply impedance.
- *3. Direct application of DC power is not presently supported by the P1000's UL listing.
- *4. Rated motor capacity is calculated with a rated output voltage of 460V.
- *5. Carrier frequency is set to 2 kHz. Current derating is required in order to raise the carrier frequency.

Specifications

600V Class

Model	CIMR-PU5A	0003	0004	0006	0009	0011	0017	0022	0027	0032		
Max. Applicable Motor Capacity ^{*1}	HP	2	3	5	7.5	10	15	20	25	30		
Input	Rated Input Current ^{*2}	A	3.6	5.1	8.3	12	16	23	31	38	45	
	Rated Output Capacity ^{*3,*4}	kVA	2.7	3.9	6.1	9	11	17	22	27	32	
Output	Rated Output Current ^{*4}	A	2.7	3.9	6.1	9	11	17	22	27	32	
	Overload Tolerance		120% of rated output current for 60 sec.									
Power	Carrier Frequency		2 to 15 kHz									
	Max. Output Voltage		Three-phase: 500 to 600 V (proportional to input voltage)									
	Max. Output Frequency		400 Hz									
	Rated Voltage/Rated Frequency		Three-phase 500 to 600 Vac 50/60 Hz									
Power	Allowable Voltage Fluctuation		-10 (-15) to +10%									
	Allowable Frequency Fluctuation		±5%									
	Fan		No fan			With fan						
	DC Link Choke		External option									
	Power Supply	kVA	4.1	5.8	9.5	14	18	26	35	43	51	

Model	CIMR-PU5A	0041	0052	0062	0077	0099	0125	0145	0192	0242	
Max. Applicable Motor Capacity ^{*1}	HP	40	50	60	75	100	125	150	200	250	
Input	Rated Input Current ^{*2}	A	41	52	62	77	99	129	158	228	263
	Rated Output Capacity ^{*3,*4}	kVA	41	52	62	77	99	124	144	191	241
Output	Rated Output Current ^{*4}	A	41	52	62	77	99	125	145	192	242
	Overload Tolerance		120% of rated output current for 60 sec.								
Power	Carrier Frequency		2 to 15 kHz								
	Max. Output Voltage		Three-phase: 500 to 600 V (proportional to input voltage)								
	Max. Output Frequency		400 Hz (user-set)								
	Rated Voltage/Rated Frequency		Three-phase 500 to 600 Vac 50/60 Hz								
Power	Allowable Voltage Fluctuation		-10 (-15) to +10%								
	Allowable Frequency Fluctuation		±5%								
	Fan		With fan								
	DC Link Choke		Included								
	Power Supply	kVA	50	62	75	91	123				

- *1. The motor capacity (HP) refers to a NEC rated 4-pole motor. The rated output current of the drive output amps should be equal to or greater than the motor current. Select the appropriate capacity drive if operating the motor continuously above motor nameplate current.
- *2. Assumes operation at the rated output current. Input current rating varies depending on the power supply transformer, input reactor, wiring connections, and power supply impedance.
- *3. Rated motor capacity is calculated with a rated output voltage of 575V.
- *4. Carrier frequency is set to 2 kHz. Current derating is required to raise the carrier frequency.

Common Specifications

Item	Specifications	
Control Characteristics	Control Methods	V/f Control (V/f)
	Frequency Control Range	0.01 to 400 Hz
	Frequency Accuracy (Temperature Fluctuation)	Digital input: within $\pm 0.01\%$ of the max output frequency (-10 to +40 °C) Analog input: within $\pm 0.1\%$ of the max output frequency (25 °C ± 10 °C)
	Frequency Setting Resolution	Digital inputs: 0.01 Hz Analog inputs: 1/2048 of the maximum output frequency setting (11 bit plus sign)
	Output Frequency Resolution	0.001 Hz
	Frequency Setting Methods	0 to +10 V, 4 to 20 mA, Pulse Train Input, Network Communications, Keypad
	Starting Torque ^{<1>}	V/f: 150% at 3 Hz
	Speed Control Range ^{<1>}	V/f: 1:40
	Accel/Decel Time	0.0 to 6000.0 s (4 selectable combinations of independent acceleration and deceleration settings)
	V/f Characteristics	User-selected programs and V/f preset patterns possible
Main Control Functions	Momentary Power Loss Ride-Thru, Speed Search, Overtorque/Undertorque Detection, 17 Step Speed (max), Accel/decel Switch, S-curve Accel/decel, 3-wire Sequence, Auto-tuning (rotational, stationary tuning), Dwell, Cooling Fan on/off Switch, Slip Compensation, Torque Compensation, Frequency Jump, Upper/lower Limits for Frequency Reference, DC Injection Braking at Start and Stop, Overexcitation Braking, High Slip Braking, PID Control (with sleep function), Energy Saving Control, Modbus Comm. (RS-422/485 max, 115.2 kbps), Fault Restart, Application Presets, Removable Terminal Block with Parameter Backup Function, Dynamic Noise Control.	
Protection Function	Motor Protection	Electronic thermal overload relay
	Momentary Overcurrent Protection	Drive stops when output exceeds 170%
	Overload Protection	Drive stops after 60 seconds at 120% of rated output current ^{<2>}
	Overvoltage Protection	240V class: Faults when DC bus voltage exceeds approx. 410 V; 480V class: Faults when DC bus voltage exceeds approx. 820 V; 600V class: Faults when DC bus voltage exceeds approx. 1040 V.
	Undervoltage Protection	240V class: Faults when DC bus voltage falls below approx. 190 V; 480V class: Faults when DC bus voltage falls below approx. 380 V; 600V class: Faults when DC bus voltage falls below approx. 475 V.
	Momentary Power Loss Ride-Thru	Stops modulating after 15 ms or longer power loss ^{<3>} . Resumes operation if power loss is less than 2 s (standard) ^{<4>}
	Heatsink Overheat Protection	Thermistor
	Stall Prevention	Stall Prevention is available during acceleration, deceleration, and during run.
	Ground Fault Protection	Electronic circuit protection ^{<5>}
Charge LED	Remains lit until DC bus voltage falls below 50 V	
Operating Environment	Area of Use	Indoors
	Ambient Temperature	-10 to +50°C (Chassis Installation) -10 to +40°C (Chassis with zero side clearance, or Type 1)
	Humidity	95% RH or less (no condensation)
	Storage Temperature	-20 to +60°C (short-term temperature during transportation)
	Altitude	Up to 1000 meters without derating, up to 3000 m with output current and voltage derating
	Shock	10 to 20 Hz: 9.8 m/s ² 20 to 55 Hz: 5.9 m/s ² (2A0004 to 2A0211, 4A0002 to 4A0165, and 5A0003 to 5A0032) 2.0 m/s ² (2A0250 to 2A0415 and 4A0208 to 4A0675)
Standards and Certifications	UL 508C, CSA C22.2, EN 61800-5-1	
Protection Design	IP00 enclosure, IP20/NEMA Type 1 enclosure ^{<6>}	

- <1> The accuracy of these values depends on motor characteristics, ambient conditions, and drive settings. Specifications may vary with different motors and with changing motor temperature. Contact Yaskawa for consultation.
- <2> Overload protection may be triggered when operating with 150% of the rated output current if the output frequency is less than 6 Hz.
- <3> May be shorter due to load conditions and motor speed.
- <4> A separate Momentary Power Loss Ride-Thru Unit is required for models 2A0004 to 2A0056, 4A0002 to 4A0031, and 5A0003 to 5A0032 if the application needs to continue running for up to 2 seconds during a momentary power loss.
- <5> Ground protection cannot be provided when the impedance of the ground fault path is too low, or when the drive is powered up while a ground fault is present at the output.
- <6> Removing the top protective cover or bottom conduit bracket from an IP20/NEMA Type 1 enclosure drive voids NEMA Type 1 protection while maintaining IP20 conformity. This is applicable to models 2A0004 to 2A0211, 4A0002 to 4A0165, and 5A0003 to 5A0032.

Drive Selection

Model Number Key

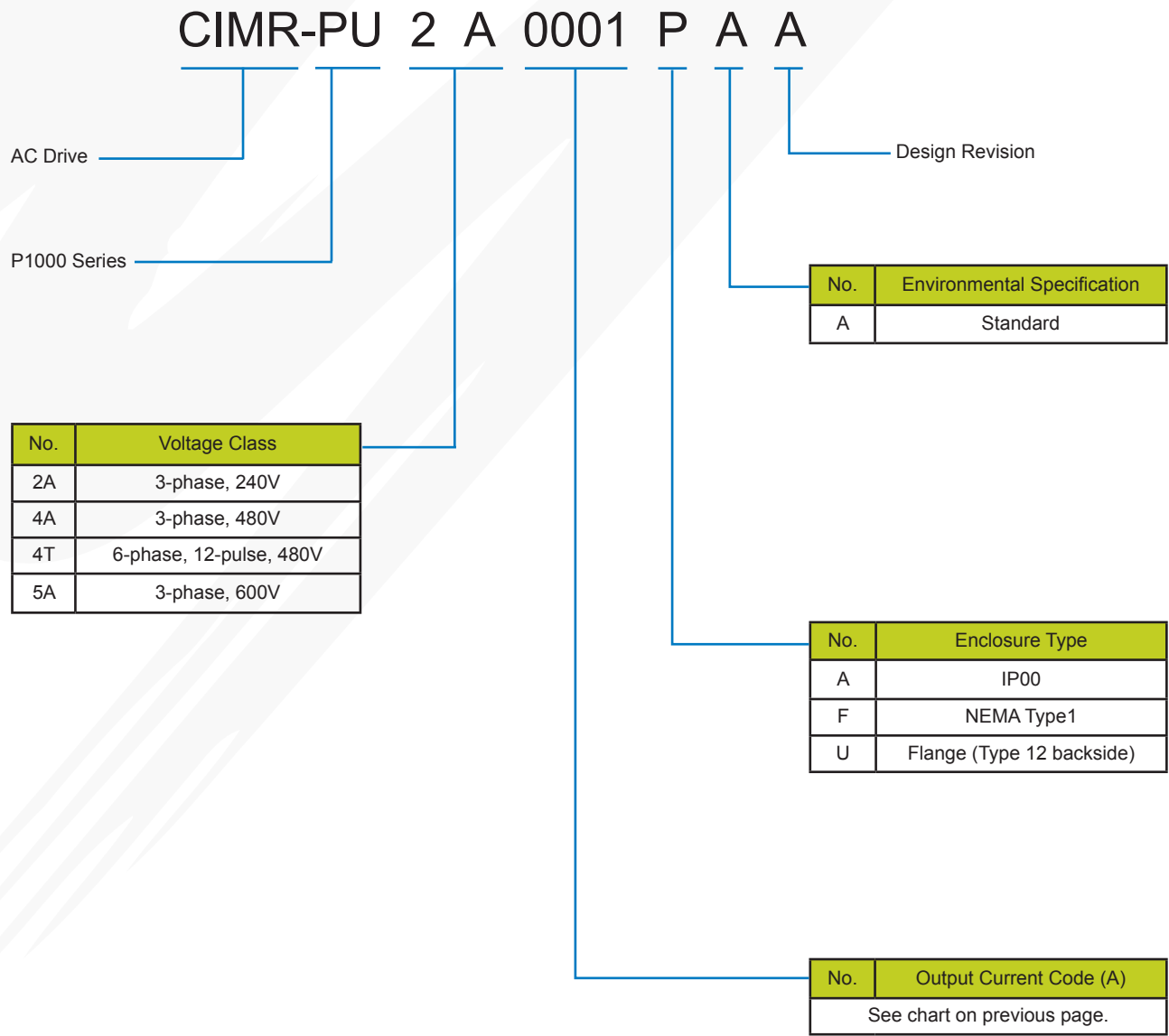

HP	Three-Phase 240V		Three-Phase 480V		Three-Phase 600V	
	Model CIMR-	Rated Output	Model CIMR-	Rated Output	Model CIMR-	Rated Output
0.75	PU2A0004	3.5 A	PU4A0002	2.1 A	PU5A0003	2.7 A
1	PU2A0006	6 A				
1.5			PU4A0004	4.1 A		
2	PU2A0008	8 A				
3	PU2A0010	9.6 A	PU4A0005	5.4 A	PU5A0004	3.9 A
	PU2A0012	12 A	PU4A0007	6.9 A		
5	PU2A0018	17.5 A	PU4A0009	8.8 A	PU5A0006	6.1 A
7.5	PU2A0021	21 A	PU4A0011	11.1 A	PU5A0009	9 A
10	PU2A0030	30 A	PU4A0018	17.5 A	PU5A0011	11 A
15	PU2A0040	40 A	PU4A0023	23 A	PU5A0017	17 A
20	PU2A0056	56 A	PU4A0031	31 A	PU5A0022	22 A
25	PU2A0069	69 A	PU4A0038	38 A	PU5A0027	27 A
30	PU2A0081	81 A	PU4A0044	44 A	PU5A0032	32 A
40	PU2A0110	110 A	PU4A0058	58 A	PU5A0041	41 A
50	PU2A0138	138 A	PU4A0072	72 A	PU5A0052	52 A
60	PU2A0169	169 A	PU4A0088	88 A	PU5A0062	62 A
75	PU2A0211	211 A	PU4A0103	103 A	PU5A0077	77 A
100	PU2A0250	250 A	PU4A0139	139 A	PU5A0099	99 A
125	PU2A0312	312 A	PU4A0165	165 A	PU5A0125	125 A
150	PU2A0360	360 A	PU4A0208	208 A	PU5A0145	145 A
175	PU2A0415	415 A	PU4A0250	250 A	PU5A0192	192 A
200						
250			PU4A0296	296 A	PU5A0242	242 A
300			PU4A0362	362 A		
350			PU4A0414	414 A		
400			PU4A0515	515 A		
450						
500			PU4A0675	675 A		
550						
600						
700			PU4A0930	930 A		
750						
800						
900			PU4A1200	1200 A		
1000						

- All models are also available in Flange (Type 12 backside) versions (models end with Uxx)
- 480V Models 0058 through 0675 are also available in 12 Pulse versions (models begin with CIMR-PU4T and are of the Flange type (models end with Uxx))

Control Accessories Selection

Operator Interfaces

The P1000 includes a multi-language LCD interface with Real Time Clock (RTC) as standard.

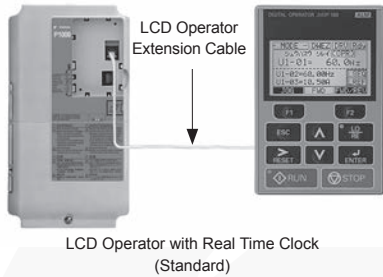

Dimensions (inches)

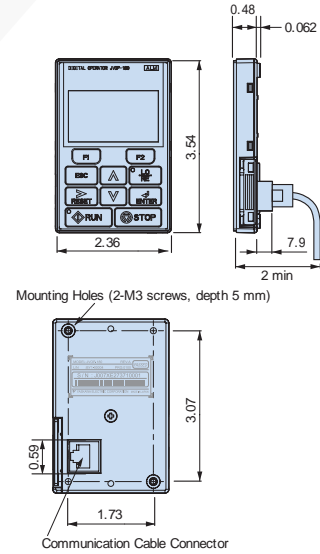

Operator

Type	Model Number	Part Number
LCD	JVOP-180C	300-035-012

Operator Extension Cables

Part Number	Description
UWR0051	3 ft Extension Cable
UWR0052	10 ft Extension Cable

For remote installation (e.g., cabinet door), use one of the following membrane kits.

Part Number	Item	Installation
UUX000526 (Blank Membrane)		
UUX000527 (Yaskawa Logo Membrane)		

USB Interface Cable

(for direct connection between the P1000 and a computer)

Requires P1000 USB device driver file, installed as part of DriveWizard® Industrial (SW.DW.30), available at Yaskawa.

Part Number	Description
UWR-0638	USB Cable, 10 ft, male A-type to male B-type

USB Copy Unit

(for downloading the same configuration to multiple drives)*

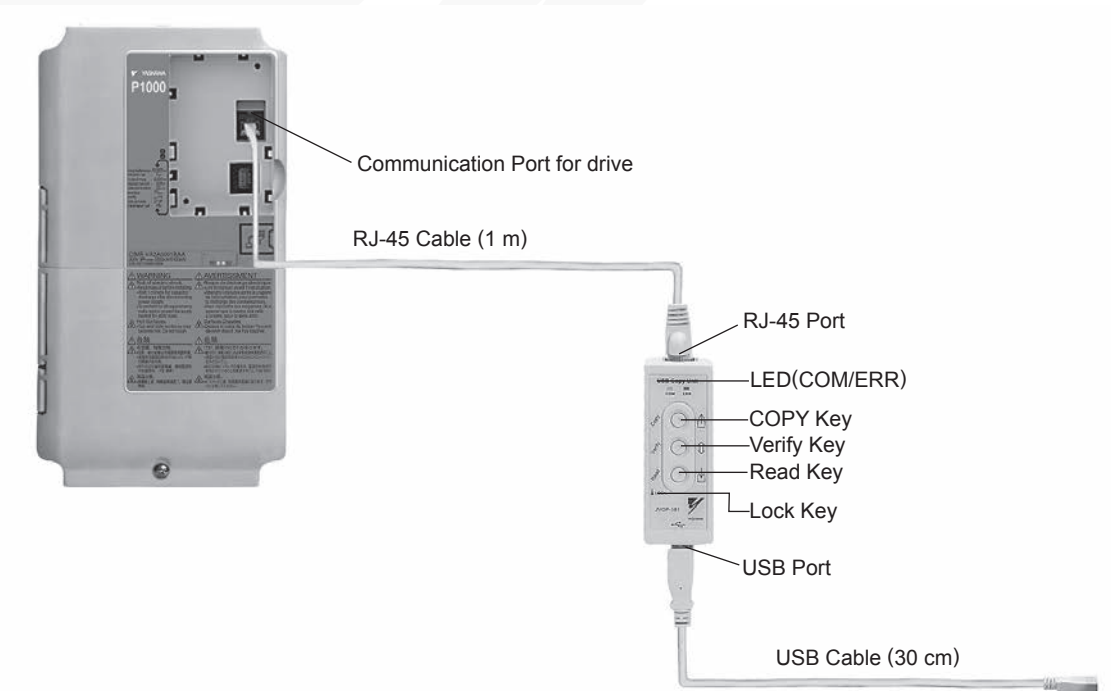

Part Number	Description
JVOP-181	USB Copy Unit with RJ-45 Cable and USB Cable

* Parameters can only be downloaded to a drive when the voltage class, capacity, control mode, and software version match

Mechanical Accessories Selection

Adapter Plates

Adapter Plates are used when replacing a P7 drive with a P1000, or when using a P7 pancake-mounted C1 filter. They consist of a simple plate the height and width (and with holes drilled for the mounting of) a P7 drive, with additional holes to match the mounting dimensions of the smaller P1000. This provides for a means to mount the P1000 drive to the plate; the drive/plate assembly may then be mounted using the old P7 mounting holes.

240V Class		
Model CIMR-PU2A	Part Number EZZ020801□	
0004	A	
0006		
0008		
0010		
0012		
0018		
0021		
0030		
0040		B
0056		C
0069	E	
0081		
0110	Not Required	
0138		
0169	F	
0211		
0250	L	
0312		
0360	M	
0415	N	

480V Class		
Model CIMR-PU4A	Part Number EZZ020801□	
0002	A	
0004		
0005		
0007		
0009		
0011		
0018		
0023		B
0031		C
0038		D
0044	E	
0058	G	
0072	Not Required	
0088	H	
0103	J	
0139	Not Required	
0165	K	
0208	L	
0250	M	
0296		
0362	N	
0414	P	
0515	Consult Factory	
0675		
0930	Not Available	
1200		

NEMA 1 Endcap Kits

This option consists of a top and bottom cover to convert a protected chassis drive to a NEMA 1 enclosed unit. This option DOES NOT provide additional space for mounting auxiliary components (i.e., circuit breaker, input fuses, reactor, etc.)

240V Class	
Model CIMR-PU2A	Part Number
0110 ⁽¹⁾	EZZ021136A
0138 ⁽¹⁾	EZZ021136B
0169 ⁽¹⁾	EZZ021136C
0211 ⁽¹⁾	
0250	EZZ021136D
0312	
0360	EZZ021136E

600V Class	
Model CIMR-PU5A	Part Number
0041 ⁽¹⁾	EZZ021136G
0052 ⁽¹⁾	
0062 ⁽¹⁾	EZZ021136C
0077 ⁽¹⁾	
0099 ⁽¹⁾	
0125	EZZ021136D
0145	
0192	EZZ021136E
0242	

480V Class	
Model CIMR-PU2A	Part Number
0058 ⁽¹⁾	EZZ021136F
0072 ⁽¹⁾	EZZ021136G
0088 ⁽¹⁾	EZZ021136H
0103 ⁽¹⁾	
0139 ⁽¹⁾	EZZ021136C
0165 ⁽¹⁾	
0208	EZZ021136D
0250	EZZ021136E
0296	
0362	
0414 ⁽²⁾	UUX000662
0515 ⁽²⁾	UUX000663
0675 ⁽²⁾	
0930 ^(2,3)	UUX000664
1200 ^(2,3)	
0930 ^(2,3)	UUX000663S
1200 ^(2,3)	

Notes:

(1) These ratings are already available as NEMA 1 (FAA) drives; the End Cap Kits for these ratings are shown here only for replacement purposes.

(2) Models 414 and larger will require special order drive part numbers to ensure compatibility with NEMA 1 kits. Consult factory.

(3) UUX000664 is a floor mount base that mounts underneath models 0930 and 1200. UUX000664S is an optional standoff kit which provides 5 in. of clearance between floor and bottom of mounting base.

External Heatsink Kits

When mounting standard drives with heatsink external (NEMA 1 backside), the following models require a separately sold bracket kit. Larger standard drives include brackets that must be detached from the back and reattached at the midpoint.

When mounting flange drives (models ending in Uxx), a "flange" feature is integral to the design, and therefore these kits are not used.

240V Class	
Model CIMR-PU2A	Part Number EZZ020800□
0004	A
0006	
0008	
0010	
0012	B
0018	
0021	
0030	
0040	
0056	C
0069	D
0081	

480V Class	
Model CIMR-PU4A	Part Number EZZ020800□
0002	A
0004	
0005	
0007	B
0009	
0011	
0018	
0023	C
0031	
0038	D
0044	

240V Class	
Model CIMR-PU5A	Part Number EZZ020800□
0003	A
0004	
0006	B
0009	
0011	
0017	C
0022	
0027	D
0032	

Capacitor Guards

Capacitor Guards are only required for P1000 IPOO models (those ending in AAA) to prevent exposure of internal components. NEMA 1 models (those ending in FAA) already include these guards as standard. Flange drives (those ending in UAA) do not require cap guards because the backside is protected by other means.

240V Class	
Model CIMR-PU2A	Part Number
0004-0211	Not Required
0250	EZZ021352E
0312	
0360	EZZ021352F
0415	

600V Class	
Model CIMR-PU5A	Part Number
0003-0099	Not Required
0125	EZZ021352E
0145	
0192	EZZ021352F
0242	

480V Class	
Model CIMR-PU2A	Part Number EZZ020801□
0002-0165	Not Required
0208	EZZ021352E
0250	EZZ021352F
0296	
0362	EZZ021352G
0414	
0515	EZZ021352H
0675	
0930	EZZ021352J
1200	

Power Accessories Selection

Reactors

Reactors are used either within the DC link circuit of a drive or at the drive's AC input terminals (line reactor). In both cases, the reactor adds impedance which can extend the life of a drive (when used on large power sources with low impedance), and reduce drive induced harmonic currents. In addition, AC reactors can be used at the drive's output terminals (load reactor) to help address a variety of installation challenges such as peak motor voltages that can occur with long motor cables.

P1000 drives 40 HP and larger have a built-in DC link reactor that provides 3% equivalent line reactance. P1000 drives 30 HP and less have terminals to add an external DC link reactor. AC line reactors can be added to all P1000 drives to add additional impedance.

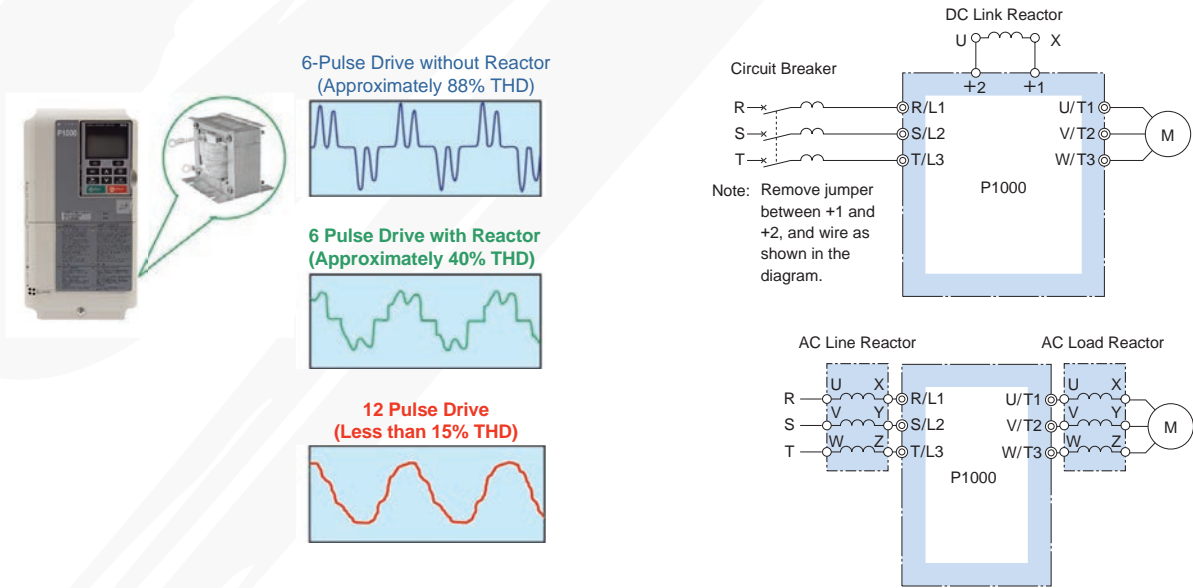

DC Link Reactors

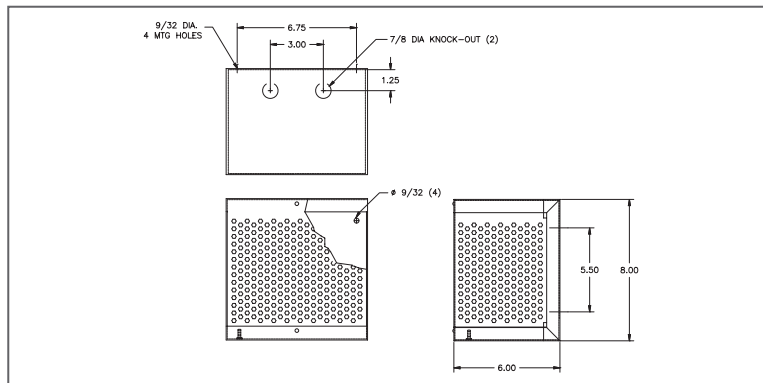
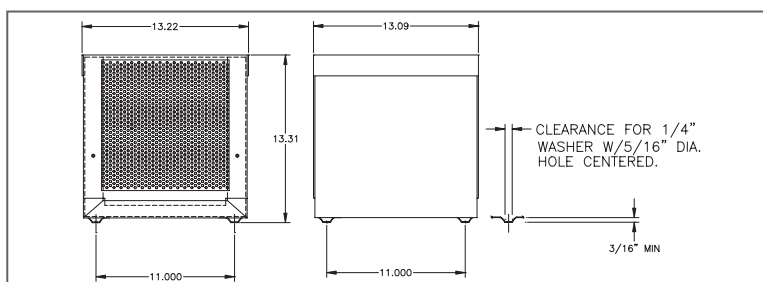

Fig. 1



DC Link Reactors (continued)

240V Class

HP	Drive Model Number: CIMR-PU2A	Built-in DC Link Reactor	3% Enclosed Reactor								
			Rated DC Current (A)	Inductance (μH)	Yaskawa Part Number	Dimensions (in.)				Weight (lb)	Watt Loss (W)
						Figure	L	W	H		
0.5	0004	No	2	10000	URX000036*	1	2.81	1.73	2.50	1	3
0.75	0004	No	4	5000	05P00608-3007*	1	2.81	1.50	2.50	1	4
1	0006	No	4	5000	05P00608-3007*	1	2.81	1.50	2.50	1	4
1.5	0006	No	9	3220	URX000257	1	8.00	6.00	8.00	9	7
2	0008	No	9	3220	URX000257	1	8.00	6.00	8.00	9	7
3	0010	No	12	2100	URX000258	1	8.00	6.00	8.00	11	7
5	0018	No	18	1375	URX000259	1	8.00	6.00	8.00	11	9
7.5	0021	No	25	1000	URX000051*	2	3.81	2.82	4.50	4	12
10	0030	No	32	850	URX000261	1	8.00	6.00	8.00	12	11
15	0040	No	50	625	URX000262	1	8.00	6.00	8.00	15	18
20	0056	No	62	320	URX000264	2	13.22	13.09	13.00	26	17
25	0069	No	80	310	0500620-0129*	2	4.63	6.00	4.00	9	20
30	0081	No	92	200	URX000266	2	13.22	13.09	13.00	28	19
40 to 175	Built-in										

HP	Drive Model Number: CIMR-PU2A	Built-in DC Link Reactor	5% Enclosed Reactor								
			Rated DC Current (A)	Inductance (μH)	Yaskawa Part Number	Dimensions (in.)				Weight (lb)	Watt Loss (W)
						Figure	L	W	H		
0.5	0004	No	2	20000	0500652-0228*	1	3.00	1.50	2.50	1	4
0.75	0004	No	4	12000	URX000207	1	8.00	6.00	8.00	9	5
1	0006	No	4	12000	URX000207	1	8.00	6.00	8.00	9	5
1.5	0006	No	9	7500	URX000208	1	8.00	6.00	8.00	11	11
2	0008	No	9	7500	URX000208	1	8.00	6.00	8.00	11	11
3	0010	No	12	4000	URX000209	1	8.00	6.00	8.00	11	11
5	0018	No	18	2750	URX000210	1	8.00	6.00	8.00	14	16
7.5	0021	No	25	1750	URX000211	1	8.00	6.00	8.00	14	13
10	0030	No	32	1620	URX000223	2	13.22	13.09	13.00	28	14
15	0040	No	50	970	URX000060*	2	4.63	5.25	5.25	14	19
20	0056	No	62	610	URX000213	2	13.22	13.09	13.00	32	20
25	0069	No	80	500	URX000069*	2	4.63	7.00	4.00	14	22
30	0081	No	92	600	URX000265	2	13.22	13.09	13.00	41	34
40 to 175	Built-in										

* Does not include NEMA 1 enclosure.

Power Accessories Selection

DC Link Reactors (continued)

480V Class

HP	Drive Model Number: CIMR-PU4A	Built-in DC Link Reactor	3% Enclosed Reactor								
			Rated DC Current (A)	Inductance (μH)	Yaskawa Part Number	Dimensions (in.)			Weight (lb)	Watt Loss (W)	
						Figure	L	W			H
0.5	0002	No	2	50000	URX000215	1	8.00	6.00	8.00	9	5
0.75	0002	No	2	20000	05P00652-0228*	1	3.00	1.50	2.50	1	4
1	0002	No	2	20000	05P00652-0228*	1	3.00	1.50	2.50	1	4
1.5	0004	No	4	15000	URX000217	1	8.00	6.00	8.00	9	6
2	0004	No	4	15000	URX000217	1	8.00	6.00	8.00	9	6
3	0005	No	9	7500	URX000208	1	8.00	6.00	8.00	11	11
5	0009	No	9	7500	URX000208	1	8.00	6.00	8.00	11	11
7.5	0011	No	12	4000	URX000209	1	8.00	6.00	8.00	11	11
10	0018	No	18	2750	URX000210	1	8.00	6.00	8.00	14	16
15	0023	No	25	1750	URX000211	1	8.00	6.00	8.00	14	13
20	0031	No	32	1620	URX000223	2	13.22	13.09	13.00	28	14
25	0038	No	40	1000	URX000184	1	8.00	6.00	8.00	15	17
30	0044	No	50	970	URX000060*	2	4.63	5.25	5.25	14	19
40 to 1000	Built-in										

HP	Drive Model Number: CIMR-PU4A	Built-in DC Link Reactor	5% Enclosed Reactor								
			Rated DC Current (A)	Inductance (μH)	Yaskawa Part Number	Dimensions (in.)			Weight (lb)	Watt Loss (W)	
						Figure	L	W			H
0.5	0002	No	2	50000	URX000215	1	8.00	6.00	8.00	9	5
0.75	0002	No	2	50000	URX000215	1	8.00	6.00	8.00	9	5
1	0002	No	2	50000	URX000215	1	8.00	6.00	8.00	9	5
1.5	0004	No	4	25000	URX000216	1	8.00	6.00	8.00	11	9
2	0004	No	4	25000	URX000216	1	8.00	6.00	8.00	11	9
3	0005	No	9	11500	URX000218	1	8.00	6.00	8.00	14	16
5	0009	No	9	11500	URX000218	1	8.00	6.00	8.00	14	16
7.5	0011	No	12	6000	URX000219	1	8.00	6.00	8.00	11	14
10	0018	No	18	6000	URX000260	2	13.22	13.09	13.00	31	20
15	0023	No	25	4000	URX000224	2	13.22	13.09	13.00	31	16
20	0031	No	32	2680	URX000221	2	13.22	13.09	13.00	32	21
25	0038	No	40	2500	URX000225	2	13.22	13.09	13.00	39	29
30	0044	No	50	2000	URX000263	2	13.22	13.09	13.00	43	30
40 to 1000	Built-in										

* Does not include NEMA 1 enclosure.

DC Link Reactors (continued)

600V Class

HP	Drive Model Number: CIMR-PU5A	Built-in DC Link Reactor	3% Enclosed Reactor								
			Rated DC Current (A)	Inductance (μH)	Yaskawa Part Number	Dimensions (in.)			Weight (lb)	Watt Loss (W)	
						Figure	L	W			H
0.5	0003	No	1	60000	URX000039*	1	3.75	2.00	3.25	2	5
0.75	0003	No	2	50000	URX000215	1	8.00	6.00	8.00	9	5
1	0003	No	2	20000	05P00652-0028*	1	3.00	1.50	2.50	1	4
1.5	0003	No	4	15000	URX000217	1	8.00	6.00	8.00	9	6
2	0003	No	4	15000	URX000217	1	8.00	6.00	8.00	9	6
3	0004	No	4	12000	URX000207	1	8.00	6.00	8.00	9	5
5	0006	No	9	7500	URX000208	1	8.00	6.00	8.00	11	11
7.5	0009	No	12	4000	URX000209	1	8.00	6.00	8.00	11	11
10	0011	No	12	4000	URX000209	1	8.00	6.00	8.00	11	11
15	0017	No	18	2750	URX000210	1	8.00	6.00	8.00	14	16
20	0022	No	25	1750	URX000211	1	8.00	6.00	8.00	14	13
25	0027	No	32	1620	URX000223	2	13.22	13.09	13.00	28	14
30	0032	No	40	1000	URX000184	1	8.00	6.00	8.00	15	17
40 to 250	Built-in										

HP	Drive Model Number: CIMR-PU5A	Built-in DC Link Reactor	5% Enclosed Reactor								
			Rated DC Current (A)	Inductance (μH)	Yaskawa Part Number	Dimensions (in.)			Weight (lb)	Watt Loss (W)	
						Figure	L	W			H
0.5	0003	No	1	80000	URX000035*	1	3.75	1.75	3.25	1	4
0.75	0003	No	2	50000	URX000215	1	8.00	6.00	8.00	9	5
1	0003	No	2	50000	URX000215	1	8.00	6.00	8.00	9	5
1.5	0003	No	4	25000	URX000216	1	8.00	6.00	8.00	11	9
2	0003	No	4	25000	URX000216	1	8.00	6.00	8.00	11	9
3	0004	No	4	25000	URX000216	1	8.00	6.00	8.00	11	9
5	0006	No	9	11500	URX000218	1	8.00	6.00	8.00	14	16
7.5	0009	No	12	6000	URX000219	1	8.00	6.00	8.00	11	14
10	0011	No	18	3750	URX000220	1	8.00	6.00	8.00	15	17
15	0017	No	25	4000	URX000224	2	13.22	13.09	13.00	31	16
20	0022	No	25	4000	URX000224	2	13.22	13.09	13.00	31	16
25	0027	No	32	2680	URX000221	2	13.22	13.09	13.00	32	21
30	0032	No	50	2000	URX000263	2	13.22	13.09	13.00	43	30
40 to 250	Built-in										

* Does not include NEMA 1 enclosure.

Power Accessories Selection

AC Line / Load Reactors

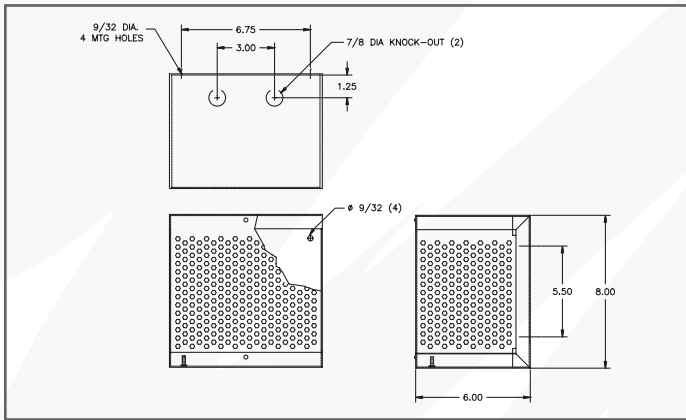

Fig. 1

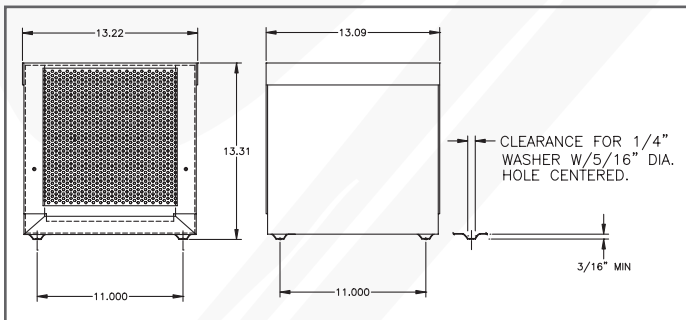

Fig. 2

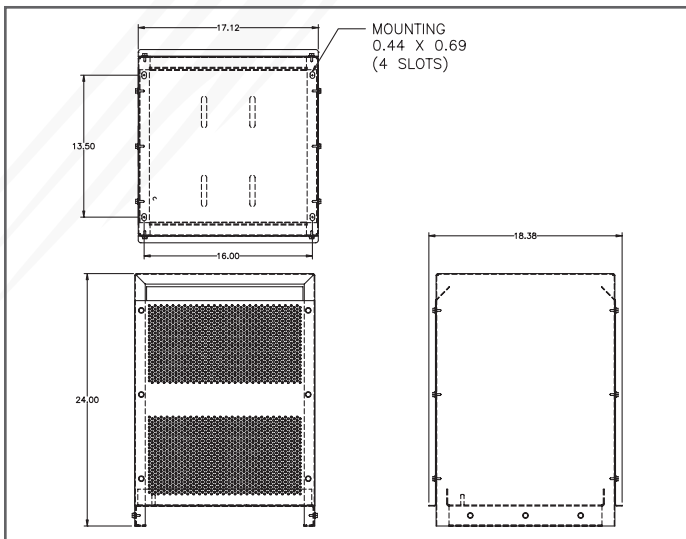
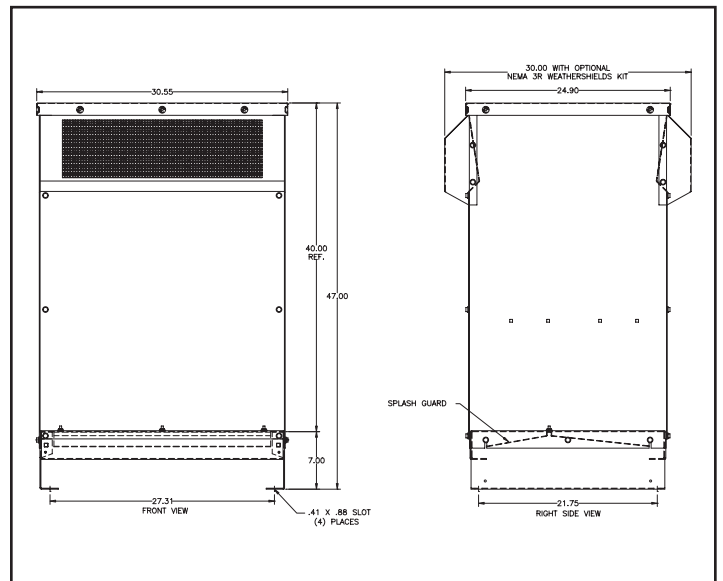
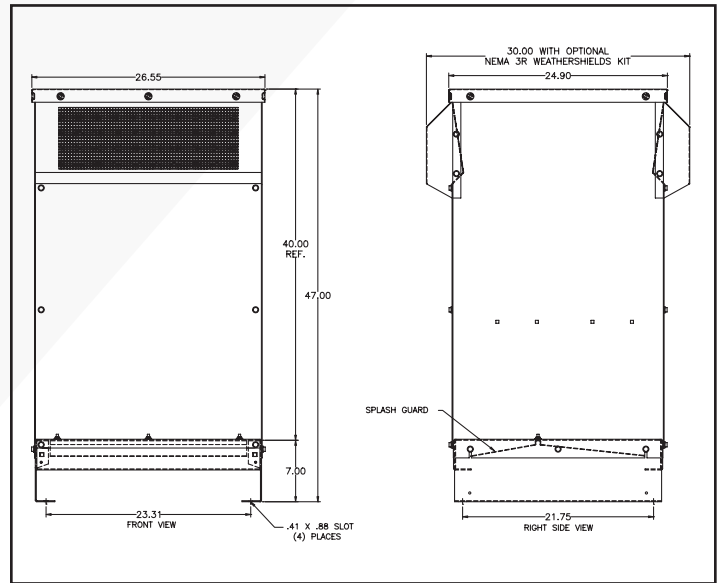

Fig. 3



AC Line / Load Reactors (continued)

240V Class

HP	Drive Model Number: CIMR-PU2A	Built-in DC Link Reactor	Nominal 3% Impedance*								
			Reactor Rated Current (A)	Inductance (μH)	Enclosed Yaskawa Part Number	Dimensions (in.)			Weight (lb)	Watt Loss (W)	
						Figure	L	W			H
0.5	0004	No	2	6000	URX000243	1	8.00	6.00	8.00	10	10.7
0.75	0004	No	4	3000	05P00620-0020		8.00	6.00	8.00	11	14.5
1	0006	No	4	3000	05P00620-0020		8.00	6.00	8.00	11	14.5
1.5	0006	No	8	1500	05P00620-0027		8.00	6.00	8.00	14	19.5
2	0008	No	8	1500	05P00620-0027		8.00	6.00	8.00	14	19.5
3	0010	No	12	1250	05P00620-0032		8.00	6.00	8.00	16	26
5	0018	No	18	800	05P00620-0036		8.00	6.00	8.00	16	36
7.5	0021	No	25	500	05P00620-0041	2	13.22	13.09	13.00	29	48
10	0030	No	35	400	05P00620-0046		13.22	13.09	13.00	32	49
15	0040	No	45	300	05P00620-0050		13.22	13.09	13.00	41	54
20	0056	No	55	250	05P00620-0054		13.22	13.09	13.00	42	64
25	0069	No	80	200	05P00620-0058		13.22	13.09	13.00	43	82
30	0081	No	80	200	05P00620-0058		13.22	13.09	13.00	43	82
40	0110	Yes	100	150	URX000204		13.22	13.09	13.00	47	94
50	0138	Yes	130	100	05P00620-0066	13.22	13.09	13.00	47	108	
60	0169	Yes	160	75	URX000206	13.22	13.09	13.00	59	116	
75	0211	Yes	250	45	URX000248	13.22	13.09	13.00	65	154	
100	0250	Yes	250	45	URX000248	13.22	13.09	13.00	65	154	
125	0312	Yes	320	40	URX000249	3	18.38	16.88	24.00	107	224
150	0360	Yes	400	30	URX000250		18.38	16.88	24.00	111	231
175	0415	Yes	500	25	URX000251		18.38	16.88	24.00	111	231

* Large P1000 drives have a built-in DC link reactor equivalent to 3% line reactance. 240V ratings are shown with 3% added AC reactance for 6% total.

HP	Drive Model Number: CIMR-PU2A	Built-in DC Link Reactor	Nominal 5% Impedance*								
			Reactor Rated Current (A)	Inductance (μH)	Enclosed Yaskawa Part Number	Dimensions (in.)			Weight (lb)	Watt Loss (W)	
						Figure	L	W			H
0.5	0004	No	2	12000	05P00620-0015	1	8.00	6.00	8.00	11	7.5
0.75	0004	No	4	6500	05P00620-0021		8.00	6.00	8.00	11	20
1	0006	No	4	6500	05P00620-0021		8.00	6.00	8.00	11	20
1.5	0006	No	8	3000	05P00620-0028		8.00	6.00	8.00	15	29
2	0008	No	8	3000	05P00620-0028		8.00	6.00	8.00	15	29
3	0010	No	12	2500	05P00620-0033		8.00	6.00	8.00	17	31
5	0018	No	18	1500	05P00620-0037		8.00	6.00	8.00	15	43
7.5	0021	No	25	1200	05P00620-0042	2	13.22	13.09	13.00	32	52
10	0030	No	35	800	05P00620-0047		13.22	13.09	13.00	34	54
15	0040	No	45	700	05P00620-0051		13.22	13.09	13.00	46	62
20	0056	No	55	500	05P00620-0055		13.22	13.09	13.00	45	67
25	0069	No	80	400	05P00620-0059		13.22	13.09	13.00	51	86
30	0081	No	80	400	05P00620-0059		13.22	13.09	13.00	51	86
40	0110	Yes	100	150	URX000204		13.22	13.09	13.00	47	94
50	0138	Yes	130	100	05P00620-0066	13.22	13.09	13.00	47	108	
60	0169	Yes	160	75	URX000206	13.22	13.09	13.00	59	116	
75	0211	Yes	250	45	URX000248	13.22	13.09	13.00	65	154	
100	0250	Yes	250	45	URX000248	13.22	13.09	13.00	65	154	
125	0312	Yes	320	40	URX000249	3	18.38	16.88	24.00	107	224
150	0360	Yes	400	30	URX000250		18.38	16.88	24.00	111	231
175	0415	Yes	500	25	URX000251		18.38	16.88	24.00	111	231

* Large P1000 drives have a built-in DC link reactor equivalent to 3% line reactance. 240V ratings are shown with 3% added AC reactance for 6% total.

Power Accessories Selection

AC Line / Load Reactors (continued)

480V Class

HP	Drive Model Number: CIMR-PU4A	Built-in DC Link Reactor	Nominal 3% Impedance*									
			Reactor Rated Current (A)	Inductance (μH)	Enclosed Yaskawa Part Number	Dimensions (in.)			Weight (lb)	Watt Loss (W)		
						Figure	L	W			H	
0.5	0002	No	1	18000	URX000242	1	8.00	6.00	8.00	11	9.6	
0.75	0002	No	2	12000	05P00620-0015		8.00	6.00	8.00	11	7.5	
1	0002	No	2	12000	05P00620-0015		8.00	6.00	8.00	11	7.5	
1.5	0004	No	4	6500	05P00620-0021		8.00	6.00	8.00	11	20	
2	0004	No	4	6500	05P00620-0021		8.00	6.00	8.00	11	20	
3	0005	No	8	3000	05P00620-0028		8.00	6.00	8.00	15	29	
5	0009	No	8	3000	05P00620-0028		8.00	6.00	8.00	15	29	
7.5	0011	No	12	2500	05P00620-0033		8.00	6.00	8.00	17	31	
10	0018	No	18	1500	05P00620-0037		8.00	6.00	8.00	19	43	
15	0023	No	25	1200	05P00620-0042	2	13.22	13.09	13.00	32	52	
20	0031	No	35	800	05P00620-0047		13.22	13.09	13.00	34	54	
25	0038	No	35	800	05P00620-0047		13.22	13.09	13.00	34	54	
30	0044	No	45	700	05P00620-0051		13.22	13.09	13.00	46	62	
40	0058	Yes	55	250	05P00620-0054		13.22	13.09	13.00	42	64	
50	0072	Yes	80	200	05P00620-0058		13.22	13.09	13.00	43	82	
60	0088	Yes	80	200	05P00620-0058		13.22	13.09	13.00	43	82	
75	0103	Yes	100	150	URX000204		13.22	13.09	13.00	47	94	
100	0139	Yes	130	100	05P00620-0066		13.22	13.09	13.00	47	108	
125	0165	Yes	160	75	URX000206		13.22	13.09	13.00	59	116	
150	0208	Yes	200	55	05P00620-0077		13.22	13.09	13.00	56	124	
200	0250	Yes	250	45	URX000248		13.22	13.09	13.00	65	154	
250	0296	Yes	320	40	URX000249		3	18.38	16.88	24.00	107	224
300	0362	Yes	400	30	URX000250			18.38	16.88	24.00	111	231
350	0414	Yes	500	25	URX000251			18.38	16.88	24.00	120	266
400	0515	Yes	500	25	URX000251	18.38		16.88	24.00	120	266	
450	0675	Yes	600	20	URX000252	4	26.55	24.90	47.00	264	307	
500	0675	Yes	600	20	URX000252		26.55	24.90	47.00	264	307	
600	0675	Yes	750	15	URX000253	5	30.55	24.90	47.00	299	427	
660	0930	Yes	750	15	URX000253		30.55	24.90	47.00	299	427	
700	0930	Yes	900	13	URX000254		30.55	24.90	47.00	444	860	
750	0930	Yes	900	13	URX000254		30.55	24.90	47.00	444	860	
800	1200	Yes	1000	11	URX000244		30.55	24.90	47.00	479	940	
900	1200	Yes	1200	9	URX000246		30.55	24.90	47.00	584	980	
1000	1200	Yes	1200	9	URX000246		30.55	24.90	47.00	584	980	

* Large P1000 drives have a built-in DC link reactor equivalent to 3% line reactance. 480V ratings are shown with 1.5% added AC reactance for 4.5% total.

AC Line / Load Reactors (continued)

480V Class

HP	Drive Model Number: CIMR-PU4A	Built-in DC Link Reactor	Nominal 5% Impedance*								
			Reactor Rated Current (A)	Inductance (μH)	Enclosed Yaskawa Part Number	Dimensions (in.)			Weight (lb)	Watt Loss (W)	
						Figure	L	W			H
0.5	0002	No	1	36000	URX000241	1	8.00	6.00	8.00	11	11.9
0.75	0002	No	2	20000	05P00620-0016		8.00	6.00	8.00	11	11.3
1	0002	No	2	20000	05P00620-0016		8.00	6.00	8.00	11	11.3
1.5	0004	No	4	12000	05P00620-0023		8.00	6.00	8.00	13	21
2	0004	No	4	12000	05P00620-0023		8.00	6.00	8.00	13	21
3	0005	No	8	7500	URX000226		8.00	6.00	8.00	20	28
5	0009	No	8	5000	05P00620-0029		8.00	6.00	8.00	18	25.3
7.5	0011	No	12	4200	05P00620-0034		8.00	6.00	8.00	25	41
10	0018	No	18	2500	05P00620-0038	2	13.22	13.09	13.00	34	43
15	0023	No	25	1800	05P00620-0043		13.22	13.09	13.00	38	61
20	0031	No	35	1200	05P00620-0048		13.22	13.09	13.00	48	54
25	0038	No	35	1200	05P00620-0048		13.22	13.09	13.00	48	54
30	0044	No	45	1200	05P00620-0052		13.22	13.09	13.00	57	65
40	0058	Yes	55	500	05P00620-0055		13.22	13.09	13.00	45	67
50	0072	Yes	80	400	05P00620-0059		13.22	13.09	13.00	51	86
60	0088	Yes	80	400	05P00620-0059		13.22	13.09	13.00	51	86
75	0103	Yes	100	300	05P00620-0062		13.22	13.09	13.00	55	84
100	0139	Yes	130	200	05P00620-0067		13.22	13.09	13.00	61	180
125	0165	Yes	160	150	05P00620-0073	13.22	13.09	13.00	68	149	
150	0208	Yes	200	110	05P00620-0078	13.22	13.09	13.00	72	168	
200	0250	Yes	250	90	05P00620-0083	3	18.38	16.88	24.00	107	231
250	0296	Yes	320	75	05P00620-0088		18.38	16.88	24.00	129	264
300	0362	Yes	400	60	05P00620-0092		18.38	16.88	24.00	145	333
350	0414	Yes	500	50	05P00620-0096	4	26.55	24.90	47.00	262	340
400	0515	Yes	500	50	05P00620-0096		26.55	24.90	47.00	262	340
450	0675	Yes	600	40	05P00620-0100		26.55	24.90	47.00	319	414
500	0675	Yes	600	40	05P00620-0100		26.55	24.90	47.00	319	414
600	0675	Yes	750	29	05P00620-0104	5	30.55	24.90	47.00	349	630
660	0930	Yes	750	29	05P00620-0104		30.55	24.90	47.00	349	630
700	0930	Yes	900	25	URX000255		30.55	24.90	47.00	529	1020
750	0930	Yes	900	25	URX000255		30.55	24.90	47.00	529	1020
800	1200	Yes	1000	22	URX000245		30.55	24.90	47.00	567	1090
900	1200	Yes	1200	19	URX000247		30.55	24.90	47.00	599	1130
1000	1200	Yes	1200	19	URX000247		30.55	24.90	47.00	599	1130

* Large P1000 drives have a built-in DC link reactor equivalent to 3% line reactance. 480V ratings are shown with 3% added AC reactance for 6% total.

Power Accessories Selection

AC Line / Load Reactors (continued)

600V Class

HP	Drive Model Number: CIMR-PU5A	Built-in DC Link Reactor	Nominal 3% Impedance*									
			Rated AC Current (A)	Inductance (μH)	Enclosed Yaskawa Part Number	Dimensions (in.)			Weight (lb)	Watt Loss (W)		
						Figure	L	W			H	
0.5	0003	No	1	36000	URX000241	1	8.00	6.00	8.00	11	11.9	
0.75	0003	No	2	20000	05P00620-0016		8.00	6.00	8.00	11	11.3	
1	0003	No	2	20000	05P00620-0016		8.00	6.00	8.00	11	11.3	
1.5	0003	No	2	20000	05P00620-0016		8.00	6.00	8.00	11	11.3	
2	0003	No	4	9000	05P00620-0022		8.00	6.00	8.00	12	20	
3	0004	No	4	9000	05P00620-0022		8.00	6.00	8.00	12	20	
5	0006	No	8	5000	05P00620-0029		8.00	6.00	8.00	18	25.3	
7.5	0009	No	12	2500	05P00620-0033		8.00	6.00	8.00	17	31	
10	0011	No	12	2500	05P00620-0033		8.00	6.00	8.00	17	31	
15	0017	No	18	1500	05P00620-0037		8.00	6.00	8.00	19	43	
20	0022	No	25	1200	05P00620-0042		2	13.22	13.09	13.00	32	52
25	0027	No	25	1200	05P00620-0042			13.22	13.09	13.00	32	52
30	0032	No	35	800	05P00620-0047			13.22	13.09	13.00	34	54
40	0041	Yes	45	300	05P00620-0050	13.22		13.09	13.00	41	54	
50	0052	Yes	55	250	05P00620-0054	13.22		13.09	13.00	42	64	
60	0062	Yes	80	200	05P00620-0058	13.22		13.09	13.00	43	82	
75	0077	Yes	80	200	05P00620-0058	13.22		13.09	13.00	43	82	
100	0099	Yes	100	150	URX000204	13.22		13.09	13.00	47	94	
125	0125	Yes	130	100	05P00620-0066	13.22		13.09	13.00	47	108	
150	0145	Yes	160	75	URX000206	13.22		13.09	13.00	59	116	
200	0192	Yes	200	55	05P00620-0077	13.22		13.09	13.00	56	124	
250	0242	Yes	250	45	05P00620-0077	13.22		13.09	13.00	65	154	

* Large P1000 drives have a built-in DC link reactor equivalent to 3% line reactance. 600V ratings are shown with 1.5% added AC reactance for 4.5% total.

AC Line / Load Reactors (continued)

600V Class

HP	Drive Model Number: CIMR-PU5A	Built-in DC Link Reactor	Nominal 5% Impedance*								
			Rated AC Current (A)	Inductance (μH)	Enclosed Yaskawa Part Number	Dimensions (in.)			Weight (lb)	Watt Loss (W)	
						Figure	L	W			H
0.5	0003	No	1	18000	URX000242	1	8.00	6.00	8.00	11	9.6
0.75	0003	No	2	32000	URX000227		8.00	6.00	8.00	11	16
1	0003	No	2	32000	URX000227		8.00	6.00	8.00	11	16
1.5	0003	No	2	32000	URX000227		8.00	6.00	8.00	11	16
2	0003	No	4	12000	05P00620-0023		8.00	6.00	8.00	13	21
3	0004	No	4	12000	05P00620-0023		8.00	6.00	8.00	13	21
5	0006	No	8	7500	URX000226		8.00	6.00	8.00	20	28
7.5	0009	No	12	4200	05P00620-0034		8.00	6.00	8.00	25	41
10	0011	No	12	4200	05P00620-0034		8.00	6.00	8.00	25	41
15	0017	No	18	2500	05P00620-0038		2	13.22	13.09	13.00	34
20	0022	No	25	1800	05P00620-0043	13.22		13.09	13.00	38	61
25	0027	No	25	1800	05P00620-0043	13.22		13.09	13.00	38	61
30	0032	No	35	1200	05P00620-0048	13.22		13.09	13.00	48	54
40	0041	Yes	45	700	05P00620-0051	13.22		13.09	13.00	46	62
50	0052	Yes	55	500	05P00620-0055	13.22		13.09	13.00	45	67
60	0062	Yes	80	400	05P00620-0059	13.22		13.09	13.00	51	86
75	0077	Yes	80	400	05P00620-0059	13.22		13.09	13.00	51	86
100	0099	Yes	100	300	05P00620-0062	13.22		13.09	13.00	55	84
125	0125	Yes	130	200	05P00620-0067	13.22		13.09	13.00	61	180
150	0145	Yes	160	150	05P00620-0073	13.22	13.09	13.00	68	149	
200	0192	Yes	200	110	05P00620-0078	13.22	13.09	13.00	72	168	
250	0242	Yes	250	90	05P00620-0083	3	18.38	16.88	24.00	107	231

* Large P1000 drives have a built-in DC link reactor equivalent to 3% line reactance. 600V ratings are shown with 3% added AC reactance for 6% total.

Power Accessories Selection

EMC Filters

EMC filters are used to reduce high frequency noise on the input (line side) conductors to comply with CE (European) directives.

Connection Diagram

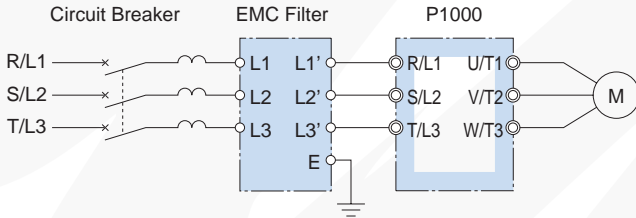

Manufactured by EPCOS (UL Listed)

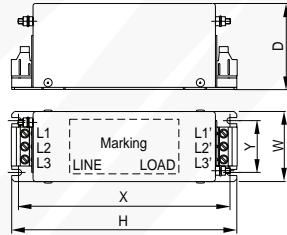

Fig. 1

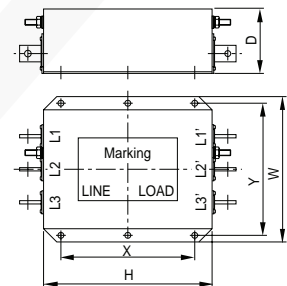

Fig. 2

EPCOS Dimensions

Yaskawa Part Number	Dimensions (in.)					Weight (lb)	Fig.
	W	D	H	X	Y		
UFI000177	2.02	2.48	6.50	1.50	6.10	1.3	1
UFI000178	1.83	2.76	9.09	1.50	8.70	2	1
UFI000179	1.83	3.27	9.09	1.50	8.70	2.4	1
UFI000180	2.28	3.54	10.43	1.38	10.04	3.9	1
UFI000181	2.28	3.54	10.43	1.38	10.04	3.9	1
UFI000182	2.28	5.57	10.43	1.38	10.04	6	1
UFI000183	3.15	5.31	11.42	2.36	10.04	9.3	1
UFI000184	3.54	5.91	11.42	2.56	10.04	10.8	1
UFI000185	3.54	5.91	10.63	2.56	10.04	11.7	1
UFI000186	7.48	4.53	11.81	6.50	9.45	33.1	2
UFI000187	10.24	4.57	11.81	9.25	9.45	46.3	2
UFI000188	10.24	4.57	11.81	9.25	9.45	46.3	2
UFI000189	10.24	4.57	13.78	9.25	11.42	48.5	2
UFI000190	11.81	6.54	13.78	10.83	11.42	61.7	2
UFI000191	11.81	9.84	15.75	10.83	13.39	75	2
UFI000192	15.16	12.60	25.59	13.98	22.05	232	2

Manufactured by Schaffner

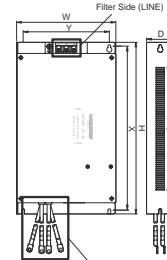

Fig. 1

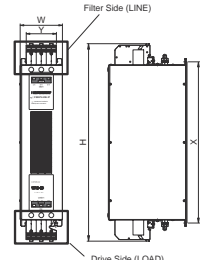

Fig. 2

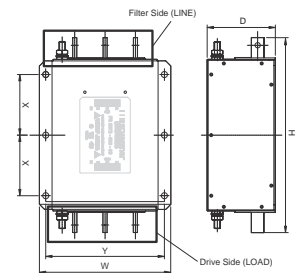

Fig. 3

Schaffner Dimensions

Yaskawa Part Number	Dimensions (in.)					Weight (lb)	Fig.
	W	D	H	X	Y		
FS5972-10-07	5.6	1.8	13	4.5	12.3	2.6	1
FS5972-18-07	5.6	1.8	13	4.5	12.3	2.9	1
FS5972-35-07	8.1	2	14	6.9	13.2	4.6	1
FS5972-60-07	9.3	2.6	16.1	8.1	15.4	8.8	1
FS5972-100-35	3.5	5.9	13	2.6	10	7.5	2
FS5972-170-40	4.7	6.7	17.8	4	14.4	13.2	2
FS5972-250-37	5.1	9.5	24	3.5	19.6	25.8	2
FS5972-410-99	10.2	4.5	15.2	9.3	4.7	23.1	3
UFI000032	10.2	5.3	15.2	9.3	4.7	24.3	3
UFI000033	11.8	6.3	28.2	10.8	8.3	31.5	3

EMC Filters (continued)

240V Class

HP	Drive Model Number CIMR-PU2A	EMC Filter by EPCOS			EMC Filter by Schaffner		
		Yaskawa Part Number	Qty.	Rated Current (A)	Yaskawa Part Number	Qty.	Rated Current (A)
0.5	0004	UFI000177	1	8	FS5972-10-07	1	10
0.75	0004	UFI000177	1	8	FS5972-10-07	1	10
1	0006	UFI000177	1	8	FS5972-10-07	1	10
1.5	0006	UFI000178	1	16	FS5972-10-07	1	10
2	0008	UFI000178	1	16	FS5972-10-07	1	10
3	0010	UFI000179	1	25	FS5972-18-07	1	18
5	0018	UFI000180	1	36	FS5972-35-07	1	35
7.5	0021	UFI000180	1	36	FS5972-35-07	1	35
10	0030	UFI000182	1	66	FS5972-60-07	1	60
15	0040	UFI000182	1	66	FS5972-60-07	1	60
20	0056	UFI000183	1	90	FS5972-100-35	1	100
25	0069	UFI000184	1	120	FS5972-100-35	1	100
30	0081	UFI000185	1	150	FS5972-170-40	1	170
40	0110	UFI000186	1	250	FS5972-170-40	1	170
50	0138	UFI000186	1	250	FS5972-250-37	1	250
60	0169	UFI000186	1	250	FS5972-250-37	1	250
75	0211	UFI000187	1	320	FS5972-410-99	1	410
100	0250	UFI000188	1	400	FS5972-410-99	1	410
125	0312	UFI000189	1	600	UFI000032	1	600
150	0360	UFI000189	1	600	UFI000032	1	600
175	0415	UFI000189	1	600	UFI000032	1	600

480V Class

HP	Drive Model Number CIMR-PU4A	EMC Filter by EPCOS			EMC Filter by Schaffner		
		Yaskawa Part Number	Qty.	Rated Current (A)	Yaskawa Part Number	Qty.	Rated Current (A)
0.75	0002	UFI000177	1	8	FS5972-10-07	1	10
2	0004	UFI000178	1	16	FS5972-10-07	1	10
3	0005/0007	UFI000178	1	16	FS5972-10-07	1	10
5	0009	UFI000179	1	25	FS5972-18-07	1	18
7.5	0011	UFI000180	1	36	FS5972-35-07	1	35
10	0018	UFI000180	1	36	FS5972-35-07	1	35
15	0023	UFI000180	1	36	FS5972-35-07	1	35
20	0031	UFI000181	1	50	FS5972-60-07	1	60
25	0038	UFI000182	1	66	FS5972-60-07	1	60
30	0044	UFI000182	1	66	FS5972-60-07	1	60
40	0058	UFI000183	1	90	FS5972-100-35	1	100
50	0072	UFI000184	1	120	FS5972-100-35	1	100
60	0088	UFI000185	1	150	FS5972-170-40	1	170
75	0103	UFI000186	1	250	FS5972-170-40	1	170
100	0139	UFI000186	1	250	FS5972-170-40	1	170
125	0165	UFI000186	1	250	FS5972-250-37	1	250
150	0208	UFI000188	1	400	FS5972-410-99	1	410
200	0250	UFI000188	1	400	FS5972-410-99	1	410
250	0296	UFI000188	1	400	FS5972-410-99	1	410
300	0362	UFI000189	1	600	UFI000032	1	600
350	0414	UFI000189	1	600	UFI000032	1	600
450	0515	UFI000190	1	1000	UFI000033	1	800
550	0675	UFI000191	1	1600	UFI000032	2	600
800	0930	UFI000192	1	2500	UFI000033	2	800
1000	1200	UFI000192	1	2500	UFI000033	2	800

Mechanical Installation Planning

Mounting Choices

The P1000 drive provides installation flexibility. For mounting outside of a cabinet in a clean environment, a NEMA 1 kit (standard on frames 1 through 10, separately sold on larger models) is available.

The standard P1000 models (ending in Axx or Fxx) can also be mounted inside of a cabinet either conventionally (heatsink internal), or with its heatsink external (NEMA 1 integrity). An external heatsink (bracket) kit is required for standard P1000 models frames 1 through 6. Brackets are included on P1000 models frames 7 and larger.

In addition, a special Flange version (ending in Uxx) exists for all sizes. This solution is a factory assembly of special brackets and gasketing to provide NEMA 12 integrity on the backside when mounting heatsink external.

External Heatsink Mounting

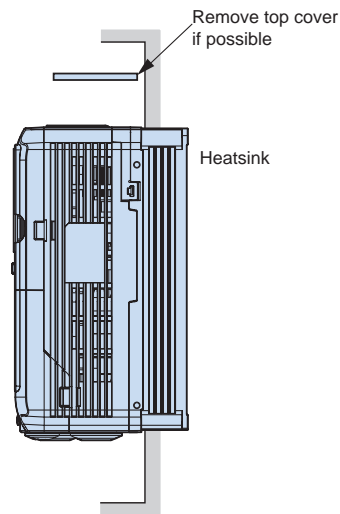
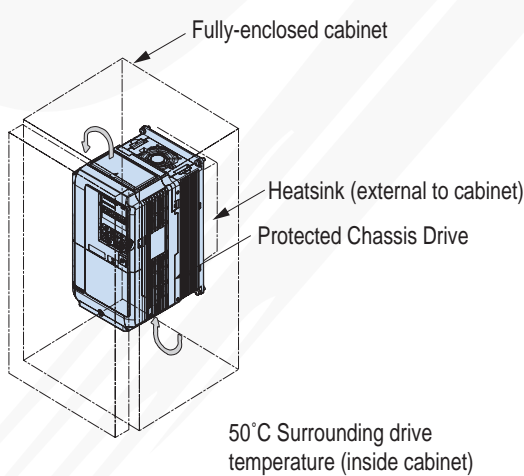

Ventilation Space

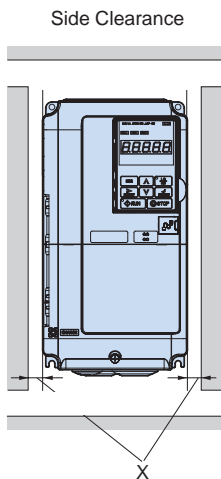

Surrounding Drive Temperature	40°C	50°C
	Side Clearance (X)	0.0 in.

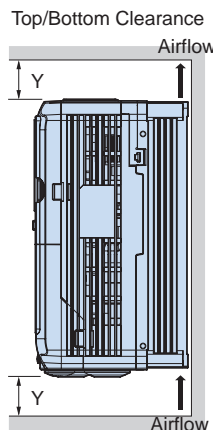

Drive Frame Size	1 - 11	12 and larger
Top/Bottom Clearance (Y)	4.72 in.	11.81 in.

Drive Dimensions

NEMA Type 1 [IP20] Diagram

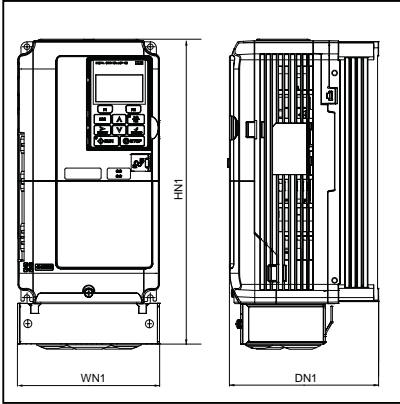

P1000 with NEMA Type 1 Kit Installed

Protected Chassis/External Heatsink Diagram

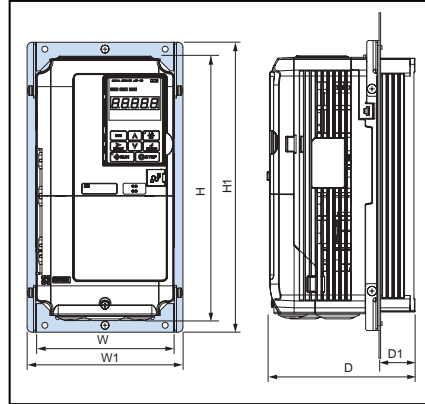

P1000 Protected Chassis / External Heatsink Configuration

Notes:

1. The diagrams shown are simplified dimensional diagrams designed to display key outer dimensions of the drive. They are meant for planning purposes only. For more detailed dimensional/mounting data, please refer to the P1000 dimensional drawings on Yaskawa website.
2. Drives with NEMA Type 1 Enclosures can be converted to protected chassis by removing the top and bottom covers.
3. When mounting standard drives with heatsink external (NEMA 1 backside), the following models require a separately sold bracket kit: CIMR-PU2A0004Fxx to 0081Fxx, CIMR-PU4A0002Fxx to 0044Fxx, and CIMR-PU5A0003Fxx to 0032Fxx. Larger standard drives include brackets that must be detached from the back and reattached at the midpoint.
4. When NEMA 12 backside integrity is required, the Flange version drives (ending with Uxx) must be ordered.

240V Class

Model CIMR-PU2A □□□□	Frame Size	Max. Applicable Motor Capacity (HP)	Dimensions (in.)									Weight (lb)	
			WN1	W	W1	HN1	H	H1	DN1	D	D1	NEMA 1	Protected Chassis
0004	1	0.75	5.51	5.51	7.64	12.06	10.24	11.81	5.79	5.79	1.34	7.3	--
0006		1.5	5.51	5.51	7.64	12.06	10.24	11.81	5.79	5.79	1.34	7.3	--
0008		2	5.51	5.51	7.64	12.06	10.24	11.81	5.79	5.79	1.34	7.5	--
0010		3	5.51	5.51	7.64	12.06	10.24	11.81	5.79	5.79	1.34	7.5	--
0012		3	5.51	5.51	7.64	12.06	10.24	11.81	5.79	5.79	1.34	7.5	--
0018	2	5	5.51	5.51	7.64	12.06	10.24	11.81	6.46	6.46	2.06	8.2	--
0021		7.5	5.51	5.51	7.64	12.06	10.24	11.81	6.46	6.46	2.06	8.2	--
0030	3	10	5.51	5.51	7.64	12.06	10.24	11.81	6.57	6.57	2.07	9.3	--
0040		15	5.51	5.51	7.64	12.06	10.24	11.81	6.57	6.57	2.07	9.3	--
0056	5	20	7.09	7.09	9.21	13.38	11.81	13.39	7.36	7.36	2.83	13.0	--
0069	6	25	8.66	8.66	11.65	15.47	13.78	16.54	7.76	7.76	2.91	20.1	--
0081		30	8.66	8.66	11.65	15.47	13.78	16.54	7.76	7.76	2.91	22.0	--
0110	7A	40	10.00	10.00	12.13	21.37	15.75	16.3	10.16	10.16	3.82	50.7	46.2
0138	8A	50	10.98	10.98	12.99	24.52	17.72	18.11	10.16	10.16	3.81	61.7	55.0
0169	10	60	12.95	12.95	15.2	30.08	21.65	22.13	11.14	11.14	4.21	90.2	81.4
0211		75	12.95	12.95	15.2	30.08	21.65	22.13	11.14	11.14	4.21	92.4	83.6
0250	11	100	17.95	17.72	22.05	37.80	27.76	28.54	12.99	12.99	5	191.8	167.6
0312		125	17.95	17.72	22.05	37.80	27.76	28.54	12.99	12.99	5	191.8	176.4
0360	12	150	19.84	19.69	23.62	45.98	31.50	32.28	13.78	13.78	5	233.7	216.1
0415		175	19.84	19.69	23.62	45.98	31.50	32.28	13.78	13.78	5	233.7	218.3

Mechanical Installation Planning

480V Class

Model CIMR-PU4A □□□□	Frame Size	Max. Applicable Motor Capacity (HP)	Dimensions (in.)									Weight (lb)	
			WN1	W	W1	HN1	H	H1	DN1	D	D1	NEMA 1	Protected Chassis
0002	1	1	5.51	5.51	7.64	12.06	10.24	11.81	5.79	5.79	1.34	7.3	--
0004		2	5.51	5.51	7.64	12.06	10.24	11.81	5.79	5.79	1.34	7.3	--
0005		3	5.51	5.51	7.64	12.06	10.24	11.81	5.79	5.79	1.34	7.3	--
0007	2	3	5.51	5.51	7.64	12.06	10.24	11.81	6.46	6.46	2.06	8.2	--
0009		5	5.51	5.51	7.64	12.06	10.24	11.81	6.46	6.46	2.06	8.2	--
0011		7.5	5.51	5.51	7.64	12.06	10.24	11.81	6.46	6.46	2.06	8.2	--
0018	3	10	5.51	5.51	7.64	12.06	10.24	11.81	6.57	6.57	2.07	9.3	--
0023		15	5.51	5.51	7.64	12.06	10.24	11.81	6.57	6.57	2.07	9.3	--
0031	4	20	7.09	7.09	9.21	13.38	11.81	13.39	6.88	6.88	2.04	12.5	--
0038	5	25	7.09	7.09	9.21	13.38	11.81	13.39	7.36	7.36	2.83	13.0	--
0044	6	30	8.66	8.66	11.65	15.47	13.78	16.54	7.76	7.76	2.91	20.1	--
0058	7B	40	10.37	10.37	12.13	18.65	15.75	16.3	10.16	10.16	3.82	50.6	50.6
0072	8B	50	11.35	11.35	12.99	20.62	17.72	18.11	10.16	10.16	3.81	59.4	59.4
0088	9	60	13.32	13.16	15.35	25.16	20.06	21.34	10.27	10.27	3.97	85.8	79.2
0103		75	13.32	13.16	15.35	25.16	20.06	21.34	10.27	10.27	3.97	85.8	79.2
0139	10	100	12.95	12.95	15.2	30.08	21.65	22.13	11.14	11.14	4.21	99.0	90.2
0165		125	12.95	12.95	15.2	30.08	21.65	22.13	11.14	11.14	4.21	101	92.4
0208	11	150	17.95	17.72	22.05	37.80	27.76	28.54	12.99	12.99	5	191	174
0250	12	200	19.84	19.69	23.62	45.98	31.50	32.28	13.78	13.78	5	233	211
0296		250	19.84	19.69	23.62	45.98	31.50	32.28	13.78	13.78	5	246	224
0362		300	19.84	19.69	23.62	45.98	31.50	32.28	13.78	13.78	5	257	235
0414	13	350	20.29	20.29	25.39	48.3	37.4	40.55	14.68	14.68	5.19	292	275
0515	14	450	26.86	26.86	31.97	61.3	44.88	46.38	14.72	14.72	7.71	504	475
0675		600	26.86	26.86	31.97	61.3	44.88	46.38	14.72	14.72	7.71	515	486
0930	15	800	50.2	49.61	--	80.4	54.33	--	14.73	14.91	--	1394	1195
1200		1000	50.2	49.61	--	80.4	54.33	--	14.73	14.91	--	1420	1221

600V Class

Model CIMR-PU5A □□□□□	Frame Size	Max. Applicable Motor Capacity (HP)	Dimensions (in.)									Weight (lb)	
			WN1	W	W1	HN1	H	H1	DN1	D	D1	NEMA 1	Protected Chassis
0003	1	2	5.51	5.51	7.64	12.06	10.24	11.81	5.79	5.79	1.34	7.3	--
0004		3	5.51	5.51	7.64	12.06	10.24	11.81	5.79	5.79	1.34	7.3	--
0006	2	5	5.51	5.51	7.64	12.06	10.24	11.81	6.46	6.46	2.06	8.2	--
0009		7.5	5.51	5.51	7.64	12.06	10.24	11.81	6.46	6.46	2.06	8.2	--
0011	3	10	5.51	5.51	7.64	12.06	10.24	11.81	6.57	6.57	2.07	9.3	--
0017	5	15	7.09	7.09	9.21	13.38	11.81	13.39	7.36	7.36	2.83	13.0	--
0022		20	7.09	7.09	9.21	13.38	11.81	13.39	7.36	7.36	2.83	13.0	--
0027	6	25	8.66	8.66	11.65	15.47	13.78	16.54	7.76	7.76	2.91	20.1	--
0032		30	8.66	8.66	11.65	15.47	13.78	16.54	7.76	7.76	2.91	20.1	--
0041	8B	40	11.35	11.35	12.99	20.62	17.72	18.11	10.16	10.16	3.81	59.4	59.4
0052		50	11.35	11.35	12.99	20.62	17.72	18.11	10.16	10.16	3.81	59.4	59.4
0062	10	60	12.95	12.95	15.2	30.08	21.65	22.13	11.14	11.14	4.21	99.0	90.2
0077		75	12.95	12.95	15.2	30.08	21.65	22.13	11.14	11.14	4.21	99.0	90.2
0099		100	12.95	12.95	15.2	30.08	21.65	22.13	11.14	11.14	4.21	99.0	90.2
0125	11	125	17.95	17.72	22.05	37.80	27.76	28.54	12.99	12.99	5	191	174
0145		150	17.95	17.72	22.05	37.80	27.76	28.54	12.99	12.99	5	191	174
0192	12	200	19.84	19.69	23.62	45.98	31.50	32.28	13.78	13.78	5	233	235
0242		250	19.84	19.69	23.62	45.98	31.50	32.28	13.78	13.78	5	257	235

Drive Watts Loss Data

240V Class

Model CIMR-PU2A	Rated Amps (A) ^{*1}	Heatsink Loss (W)	Interior Unit Loss (W)	Total Loss (W)
0004	3.5	18.4	47	66
0006	6.0	31	51	82
0008	8.0	43	52	95
0010	9.6	57	58	115
0012	12.0	77	64	141
0018	17.5	101	67	168
0021	21	138	83	222
0030	30	262	117	379
0040	40	293	145	437
0056	56	371	175	546
0069	69	491	205	696
0081	81	527	257	785
0110	110	719	286	1005
0138	138	842	312	1154
0169	169	1014	380	1394
0211	211	1218	473	1691
0250	250	1764	594	2358
0312	312	2020	665	2686
0360	360	2698	894	3591
0415	415	2672	954	3626

*1: Value assumes the carrier frequency is at default setting (refer to Technical Manual).

480V Class

Model CIMR-PU4A	Rated Amps (A) ^{*1}	Heatsink Loss (W)	Interior Unit Loss (W)	Total Loss (W)
0002	2.1	20	48	68
0004	4.1	32	49	81
0005	5.4	45	53	97
0007	6.9	62	59	121
0009	8.8	66	60	126
0011	11.1	89	73	162
0018	17.5	177	108	285
0023	23	216	138	354
0031	31	295	161	455
0038	38	340	182	521
0044	44	390	209	599
0058	58	471	215	686
0072	72	605	265	870
0088	88	684	308	993
0103	103	848	357	1205
0139	139	1215	534	1749
0165	165	1557	668	2224
0208	208	1800	607	2408
0250	250	2379	803	3182
0296	296	2448	905	3353
0362	362	3168	1130	4298
0414	414	3443	1295	4738
0515	515	4850	1668	6518
0675	675	4861	2037	6898
0930	930	8476	2952	11428
1200	1200	8572	3612	12184

*1: Value assumes the carrier frequency is at default setting (refer to Technical Manual).

Electrical Installation Planning

Connection Diagram

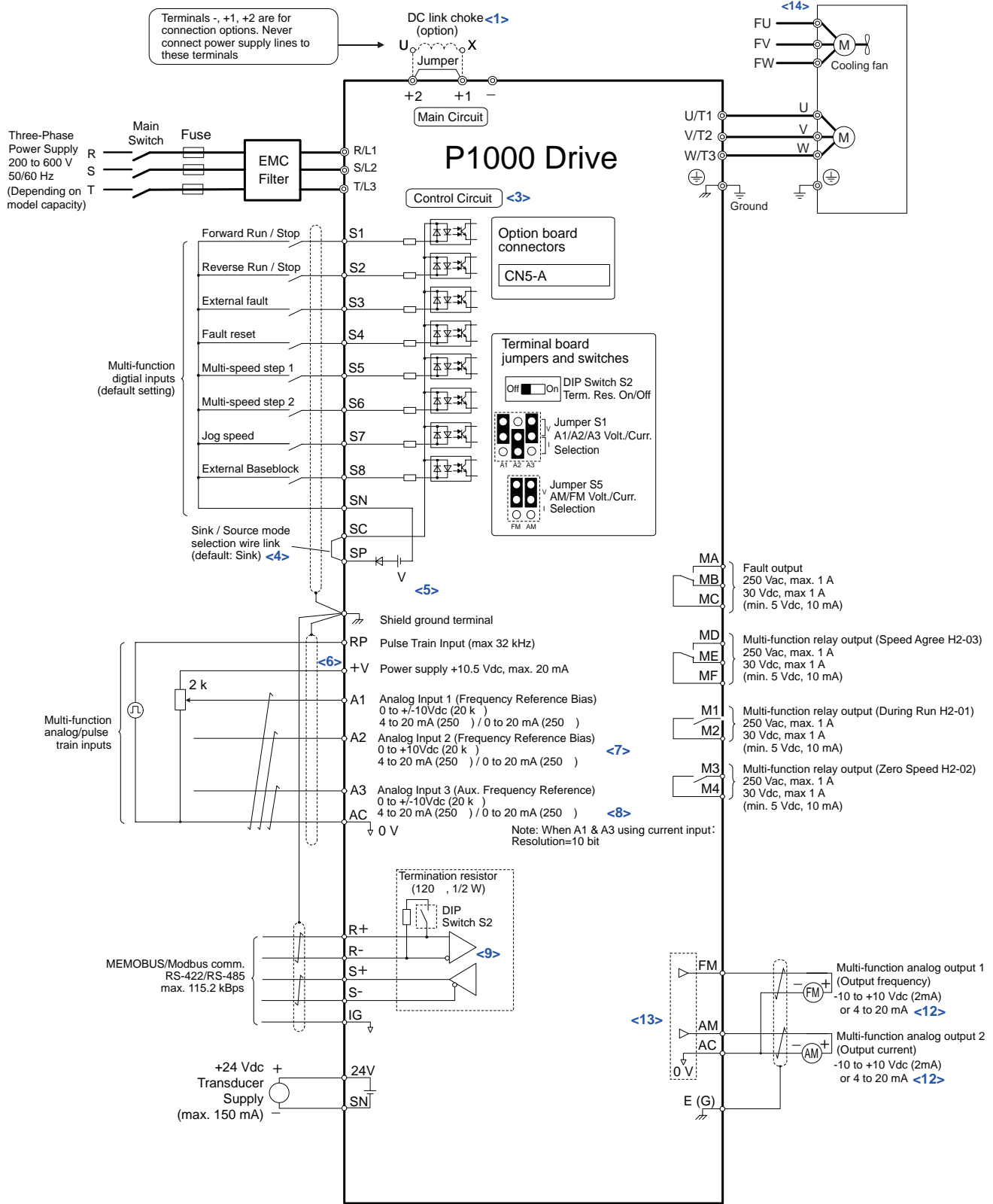

⊕ shielded line ⊗ twisted-pair shielded line ○ control circuit terminal ⊙ main circuit terminal

Electrical Installation Planning

Power Terminal Functions

240V Class

Voltage	240V			Function
Model CIMR-PU[]	2A0004 to 2A0081	2A0110, 2A0138	2A0169 to 2A0415	
Max. Applicable Motor Capacity HP	0.75 to 30	40, 50	60 to 175	
R/L1	Main circuit input power supply			Connects line power to the drive
S/L2				
T/L3				
U/T1	Drive output			Connects to the motor
V/T2				
W/T3				
+2	• DC reactor connection (+1, +2) (remove the shorting bar between +1 and +2)	Not available		For connection • of the drive to a DC power supply (terminals +1 and – are not EU/CE or UL approved) • of a DC link reactor
+1		• DC power supply input (+1, –)	• DC power supply input (+1, –)	
–	Not available			
+3	Ground terminal (100 Ω or less)			Grounding terminal

480V Class

Voltage	480V			Function
Model CIMR-PU[]	4A0002 to 4A0044	4A0058, 4A0072	4A0088 to 4A1200	
Max. Applicable Motor Capacity HP	0.75 to 30	40,50	60 to 1000	
R/L1	Main circuit input power supply			Connects line power to the drive
S/L2				
T/L3				
U/T1	Drive output			Connects to the motor
V/T2				
W/T3				
+2	• DC reactor connection (+1, +2) (remove the shorting bar between +1 and +2)	Not available		For connection • of the drive to a DC power supply (terminals +1 and – are not EU/CE or UL approved) • of a DC link reactor
+1		• DC power supply input (+1, –)	• DC power supply input (+1, –)	
–	Not available			
+3	Ground terminal (100 Ω or less)			Grounding terminal

600V Class

Voltage	600V			Function
Model CIMR-PU[]	5A0003 to 5A0032	5A0041 to 5A0099	5A0125 to 5A0242	
Max. Applicable Motor Capacity HP	1 to 30	40 to 100	125 to 250	
R/L1	Main circuit input power supply			Connects line power to the drive
S/L2				
T/L3				
U/T1	Drive output			Connects to the motor
V/T2				
W/T3				
+2	• DC reactor connection (+1, +2) (remove the shorting bar between +1 and +2)	Not available		For connection • of the drive to a DC power supply (terminals +1 and – are not EU/CE or UL approved) • of a DC link reactor
+1		• DC power supply input (+1, –)	• DC power supply input (+1, –)	
–	Not available			
+3	Ground terminal (100 Ω or less)			Grounding terminal

Control Terminal Functions

Input Terminals

Classification	Terminal	Terminal Name (Function)	Default Setting	Function (Signal Level)
Multi-function Digital Inputs	S1	Multi-function input selection 1	Closed: Forward run (Open: Stop)	<ul style="list-style-type: none"> Photocoupler 24 Vdc, 8 mA Set the S3 jumper to select between sinking, sourcing mode, and the power supply.
	S2	Multi-function input selection 2	Closed: Reverse run (Open: Stop)	
	S3	Multi-function input selection 3	External fault, N.O.	
	S4	Multi-function input selection 4	Fault reset	
	S5	Multi-function input selection 5	Multi-step speed reference 1	
	S6	Multi-function input selection 6	Multi-step speed reference 2	
	S7	Multi-function input selection 7	Jog reference	
	S8	Multi-function input selection 8	Closed: External baseblock	
	SC	Multi-function input common		Multi-function input common
	SP	Digital input power supply +24 Vdc		24 Vdc power supply for digital inputs, 150 mA max (only when not using digital input option DI-A3)
	SN	Digital input power supply 0 V		NOTICE: Do not jumper or short terminals SP and SN. Failure to comply will damage the drive
Multi-function Analog/Pulse Train Inputs	RP	Multi-function pulse train input	Frequency reference	<ul style="list-style-type: none"> Input frequency range: 0 to 32 kHz Signal Duty Cycle: 30 to 70% High level: 3.5 to 13.2 Vdc, low level: 0.0 to 0.8 Vdc Input impedance: 3 kΩ
	+V	Power supply for analog inputs		+10.5 Vdc (max allowable current 20 mA)
	+24V	Power supply for sensor feedback supply		+24 Vdc (max allowable 150 mA)
	A1	Multi-function analog input 1	Frequency reference	<ul style="list-style-type: none"> 0 to 10 Vdc (input impedance: 20 kΩ) 4 to 20 mA, 0 to 20 mA (input impedance: 250 Ω) Voltage or current input must be selected by DIP switch S1 and H3-09.
	A2	Multi-function analog input 2	Frequency reference	
	A3	Multi-function analog input 3	Auxiliary frequency reference/PTC Input	
	AC	Frequency reference common		0 V
E(G)	Ground for shielded lines and option cards		-	

Output Terminals

Classification	Terminal	Terminal Name (Function)	Default Setting	Function (Signal Level)
Fault Relay Outputs	MA	N.O		30 Vdc, 10 mA to 1 A; 250 Vac, 10 mA to 1 A Minimum load: 5 Vdc, 10 mA
	MB	NC		
	MC	Fault output common		
Multi-Function Digital Output ^{*1}	MD			30 Vdc, 10 mA to 1 A; 250 Vac, 10 mA to 1 A Minimum load: 5 Vdc, 10 mA
	ME	Multi-function digital output 1	During run	
	M1	Multi-function digital output 2	Zero speed	
	M2			
	M3	Multi-function digital output 3	Speed Agree 1	
Monitor Output	FM	Analog monitor output 1	Output frequency	-10 to +10 Vdc, or 0 to +10 Vdc
	AM	Analog monitor output 2	Output current	
	AC	Monitor common		0 V

Communication Terminals















Classification	Terminal	Signal Function	Description	Function (Signal Level)
Modbus Communication ^{*2}	R+	Communication input	Modbus communication: use an RS-485 or RS-422 cable to connect the P1000	RS-485/422 Modbus communication protocol 115.2 kbps (max.)
	R-			
	S+	Communication output		
	S-			
IG	Shield ground			





























*1: Refrain from assigning functions to digital relay outputs that involve frequent switching, as doing so may shorten relay performance life. Switching life is estimated at 200,000 times (assumes 1 A, resistive load).

*2: Enable the termination resistor in the last drive in a Modbus network by setting DIP switch S2 to the ON position.

Yaskawa Industrial Drives Family

Selection Matrix

Product	Dedicated Enclosure Types	Power Range	Performance (IM = Induction Motor) (PM = Permanent Magnet Motor)		
			Volts per Hertz	Open Loop Vector	Closed Loop Vector
A1000 General Purpose High Performance Vector	Type 1, Protected Chassis or Flange	1/2  175HP @ 240V 3-Phase 3/4  1000HP @ 480V 3-Phase 1  250HP @ 600 VAC	40:1 (IM)	200:1 (IM) 100:1 (PM)	1500:1 (IM) 1500:1 (PM)
G7 Three Level Problem Solver	Type 1 or Protected Chassis	1/2  175HP @ 240V 3-Phase 3/4  500HP @ 480V 3-Phase	40:1 (IM)	200:1 (IM)	1000:1 (IM)
P1000 Industrial Fan and Pump	Type 1, Protected Chassis or Flange	3/4  175HP @ 240V 3-Phase 1  1000HP @ 480V 3-Phase 2  250HP @ 600 VAC	40:1 (IM)		
V1000 Compact Vector	Type 1 Type 4X/12 or Protected Chassis	1/8  5HP @ 240V 1-Phase 1/8  25HP @ 240V 3-Phase 1/2  25HP @ 480V 3-Phase	40:1 (IM)	100:1 (IM) 10:1 (PM)	
J1000 Ultra Compact	Protected Chassis	1/8  3HP @ 240V 1-Phase 1/8  5HP @ 240V 3-Phase 1/2  7.5HP @ 480V 3-Phase	40:1 (IM)		

Maximum Frequency	Inputs and Outputs						Industrial Communications							Auxiliary Control Power Input	Safe-Torque-Off	
	Standard (Alternate Firmware)	Analog Inputs	Analog Outputs	Digital Inputs	Digital Outputs	Pulse Train Inputs	Pulse Train Outputs	EtherNet/IP	DeviceNet	Modbus TCP/IP	Modbus RTU	Modbus Plus	MECHATROLINK-II			PROFIBUS-DP
400 Hz (1000 Hz)	3	2	8	4	1	1										Cat 3 PLd SIL CL2
400 Hz	3	2	12	6	1	1										
400 Hz	3	2	8	4	1											
400 Hz (1167 Hz)	2	1	7	3	1	1										Cat 3 PLd SIL CL2
400 Hz	1	1	5	1												

* Some products may support additional (non-industrial) network communications. Refer to individual product documentation or contact Yaskawa for more information

 Standard
 Option



Yaskawa America, Inc.
Drives & Motion Division